

# **RIGOL**

## **User's Guide**

### **MSO1000Z/DS1000Z Series Digital Oscilloscope**

**Aug. 2016  
RIGOL TECHNOLOGIES, INC.**



# Guaranty and Declaration

## Copyright

© 2014 **RIGOL** TECHNOLOGIES, INC. All Rights Reserved.

## Trademark Information

**RIGOL** is a registered trademark of **RIGOL** TECHNOLOGIES, INC.

## Publication Number

UGA19111-1110

## Software Version

00.04.03.SP2

Software upgrade might change or add product features. Please acquire the latest version of the manual from **RIGOL** website or contact **RIGOL** to upgrade the software.

## Notices

- **RIGOL** products are covered by P.R.C. and foreign patents, issued and pending.
- **RIGOL** reserves the right to modify or change parts of or all the specifications and pricing policies at the company's sole decision.
- Information in this publication replaces all previously released materials.
- Information in this publication is subject to change without notice.
- **RIGOL** shall not be liable for either incidental or consequential losses in connection with the furnishing, use, or performance of this manual, as well as any information contained.
- Any part of this document is forbidden to be copied, photocopied, or rearranged without prior written approval of **RIGOL**.

## Product Certification

**RIGOL** guarantees that this product conforms to the national and industrial standards in China as well as the ISO9001:2008 standard and the ISO14001:2004 standard. Other international standard conformance certifications are in progress.

## Contact Us

If you have any problem or requirement when using our products or this manual, please contact **RIGOL**.

E-mail: [service@rigol.com](mailto:service@rigol.com)

Website: [www.rigol.com](http://www.rigol.com)

# Safety Requirement

## General Safety Summary

Please review the following safety precautions carefully before putting the instrument into operation so as to avoid any personal injury or damage to the instrument and any product connected to it. To prevent potential hazards, please follow the instructions specified in this manual to use the instrument properly.

### **Use Proper Power Cord.**

Only the exclusive power cord designed for the instrument and authorized for use within the local country could be used.

### **Ground the Instrument.**

The instrument is grounded through the Protective Earth lead of the power cord. To avoid electric shock, connect the earth terminal of the power cord to the Protective Earth terminal before connecting any input or output terminals.

### **Connect the Probe Correctly.**

If a probe is used, the probe ground lead must be connected to earth ground. Do not connect the ground lead to high voltage. Improper way of connection could result in dangerous voltages being present on the connectors, controls or other surfaces of the oscilloscope and probes, which will cause potential hazards for operators.

### **Observe All Terminal Ratings.**

To avoid fire or shock hazard, observe all ratings and markers on the instrument and check your manual for more information about ratings before connecting the instrument.

### **Use Proper Overvoltage Protection.**

Ensure that no overvoltage (such as that caused by a bolt of lightning) can reach the product. Otherwise, the operator might be exposed to the danger of an electric shock.

### **Do Not Operate Without Covers.**

Do not operate the instrument with covers or panels removed.

### **Do Not Insert Objects Into the Air Outlet.**

Do not insert objects into the air outlet, as doing so may cause damage to the instrument.

### **Use Proper Fuse.**

Please use the specified fuses.

**Avoid Circuit or Wire Exposure.**

Do not touch exposed junctions and components when the unit is powered on.

**Do Not Operate With Suspected Failures.**

If you suspect that any damage may occur to the instrument, have it inspected by **RIGOL** authorized personnel before further operations. Any maintenance, adjustment or replacement especially to circuits or accessories must be performed by **RIGOL** authorized personnel.

**Provide Adequate Ventilation.**

Inadequate ventilation may cause an increase of temperature in the instrument, which would cause damage to the instrument. So please keep the instrument well ventilated and inspect the air outlet and the fan regularly.

**Do Not Operate in Wet Conditions.**

To avoid short circuit inside the instrument or electric shock, never operate the instrument in a humid environment.

**Do Not Operate in an Explosive Atmosphere.**

To avoid personal injuries or damage to the instrument, never operate the instrument in an explosive atmosphere.

**Keep Instrument Surfaces Clean and Dry.**

To avoid dust or moisture from affecting the performance of the instrument, keep the surfaces of the instrument clean and dry.

**Prevent Electrostatic Impact.**

Operate the instrument in an electrostatic discharge protective environment to avoid damage induced by static discharges. Always ground both the internal and external conductors of cables to release static before making connections.

**Use the Battery Properly.**

Do not expose the battery (if available) to high temperature or fire. Keep it out of the reach of children. Improper change of a battery (lithium battery) may cause an explosion. Use the **RIGOL** specified battery only.

**Handle with Caution.**

Please handle with care during transportation to avoid damage to keys, knobs, interfaces, and other parts on the panels.

## Safety Notices and Symbols

### Safety Notices in this Manual:



---

**WARNING**

Indicates a potentially hazardous situation or practice which, if not avoided, will result in serious injury or death.

---



---

**CAUTION**

Indicates a potentially hazardous situation or practice which, if not avoided, could result in damage to the product or loss of important data.

---

### Safety Terms on the Product:

**DANGER** It calls attention to an operation, if not correctly performed, could result in injury or hazard immediately.

**WARNING** It calls attention to an operation, if not correctly performed, could result in potential injury or hazard.

**CAUTION** It calls attention to an operation, if not correctly performed, could result in damage to the product or other devices connected to the product.

### Safety Symbols on the Product:



**Hazardous Voltage**



**Safety Warning**



**Protective Earth Terminal**



**Chassis Ground**



**Test Ground**

## Allgemeine Sicherheits Informationen

Überprüfen Sie die folgenden Sicherheitshinweise sorgfältig um Personenschäden oder Schäden am Gerät und an damit verbundenen weiteren Geräten zu vermeiden. Zur Vermeidung von Gefahren, nutzen Sie bitte das Gerät nur so, wie in diesem Handbuch angegeben.

### **Um Feuer oder Verletzungen zu vermeiden, verwenden Sie ein ordnungsgemäßes Netzkabel.**

Verwenden Sie für dieses Gerät nur das für ihr Land zugelassene und genehmigte Netzkabel.

### **Erden des Gerätes.**

Das Gerät ist durch den Schutzleiter im Netzkabel geerdet. Um Gefahren durch elektrischen Schlag zu vermeiden, ist es unerlässlich, die Erdung durchzuführen. Erst dann dürfen weitere Ein- oder Ausgänge verbunden werden.

### **Anschluss eines Tastkopfes.**

Die Erdungsklemmen der Sonden sind auf dem gleichen Spannungspegel des Instruments geerdet. Schließen Sie die Erdungsklemmen an keine hohe Spannung an.

### **Beachten Sie alle Anschlüsse.**

Zur Vermeidung von Feuer oder Stromschlag, beachten Sie alle Bemerkungen und Markierungen auf dem Instrument. Befolgen Sie die Bedienungsanleitung für weitere Informationen, bevor Sie weitere Anschlüsse an das Instrument legen.

### **Verwenden Sie einen geeigneten Überspannungsschutz.**

Stellen Sie sicher, daß keinerlei Überspannung (wie z.B. durch Gewitter verursacht) das Gerät erreichen kann. Andernfalls besteht für den Anwender die Gefahr eines Stromschlages.

### **Nicht ohne Abdeckung einschalten.**

Betreiben Sie das Gerät nicht mit entfernten Gehäuse-Abdeckungen.

### **Betreiben Sie das Gerät nicht geöffnet.**

Der Betrieb mit offenen oder entfernten Gehäuseteilen ist nicht zulässig. Nichts in entsprechende Öffnungen stecken (Lüfter z.B.)

### **Passende Sicherung verwenden.**

Setzen Sie nur die spezifikationsgemäßen Sicherungen ein.

### **Vermeiden Sie ungeschützte Verbindungen.**

Berühren Sie keine unisolierten Verbindungen oder Baugruppen, während das Gerät in Betrieb ist.

**Betreiben Sie das Gerät nicht im Fehlerfall.**

Wenn Sie am Gerät einen Defekt vermuten, sorgen Sie dafür, bevor Sie das Gerät wieder betreiben, dass eine Untersuchung durch **RIGOL** autorisiertem Personal durchgeführt wird. Jedwede Wartung, Einstellarbeiten oder Austausch von Teilen am Gerät, sowie am Zubehör dürfen nur von **RIGOL** autorisiertem Personal durchgeführt werden.

**Belüftung sicherstellen.**

Unzureichende Belüftung kann zu Temperaturanstiegen und somit zu thermischen Schäden am Gerät führen. Stellen Sie deswegen die Belüftung sicher und kontrollieren regelmäßig Lüfter und Belüftungsöffnungen.

**Nicht in feuchter Umgebung betreiben.**

Zur Vermeidung von Kurzschluß im Geräteinneren und Stromschlag betreiben Sie das Gerät bitte niemals in feuchter Umgebung.

**Nicht in explosiver Atmosphäre betreiben.**

Zur Vermeidung von Personen- und Sachschäden ist es unumgänglich, das Gerät ausschließlich fernab jedweder explosiven Atmosphäre zu betreiben.

**Geräteoberflächen sauber und trocken halten.**

Um den Einfluß von Staub und Feuchtigkeit aus der Luft auszuschließen, halten Sie bitte die Geräteoberflächen sauber und trocken.

**Schutz gegen elektrostatische Entladung (ESD).**

Sorgen Sie für eine elektrostatisch geschützte Umgebung, um somit Schäden und Funktionsstörungen durch ESD zu vermeiden. Erden Sie vor dem Anschluß immer Innen- und Außenleiter der Verbindungsleitung, um statische Aufladung zu entladen.

**Die richtige Verwendung des Akku.**

Wenn eine Batterie verwendet wird, vermeiden Sie hohe Temperaturen bzw. Feuer ausgesetzt werden. Bewahren Sie es außerhalb der Reichweite von Kindern auf. Unsachgemäße Änderung der Batterie (Anmerkung: Lithium-Batterie) kann zu einer Explosion führen. Verwenden Sie nur von **RIGOL** angegebene Akkus.

**Sicherer Transport.**

Transportieren Sie das Gerät sorgfältig (Verpackung!), um Schäden an Bedienelementen, Anschlüssen und anderen Teilen zu vermeiden.



# Sicherheits Begriffe und Symbole

## Begriffe in diesem Guide:



### **WARNING**

Die Kennzeichnung WARNING beschreibt Gefahrenquellen die leibliche Schäden oder den Tod von Personen zur Folge haben können.



### **CAUTION**

Die Kennzeichnung Caution (Vorsicht) beschreibt Gefahrenquellen die Schäden am Gerät hervorrufen können.

## Begriffe auf dem Produkt:

### **DANGER**

weist auf eine Verletzung oder Gefährdung hin, die sofort geschehen kann.

### **WARNING**

weist auf eine Verletzung oder Gefährdung hin, die möglicherweise nicht sofort geschehen.

### **CAUTION**

weist auf eine Verletzung oder Gefährdung hin und bedeutet, dass eine mögliche Beschädigung des Instruments oder anderer Gegenstände auftreten kann.

## Symbole auf dem Produkt:



Gefährliche  
Spannung



Sicherheits-  
Hinweis



Schutz-erde



Gehäusemasse



Erde

# Measurement Category

## Measurement Category

MSO1000Z/DS1000Z series digital oscilloscopes can make measurements in Measurement Category I.



---

**WARNING**

This oscilloscope can only be used for measurements within its specified measurement categories.

---

## Measurement Category Definitions

Measurement category I is for measurements performed on circuits not directly connected to MAINS. Examples are measurements on circuits not derived from MAINS, and specially protected (internal) MAINS derived circuits. In the latter case, transient stresses are variable. For that reason, the transient withstand capability of the equipment is made known to the user.

Measurement category II is for measurements performed on circuits directly connected to low voltage installations. Examples are measurements on household appliances, portable tools and similar equipment.

Measurement category III is for measurements performed in building installations. Examples are measurements on distribution boards, circuit-breakers, wiring (including cables, bus-bars, junction boxes, switches and socket-outlets) in fixed installations, equipment for industrial use and some other equipment. For example, stationary motors with permanent connection to a fixed installation.

Measurement category IV is for measurements performed at the source of a low-voltage installation. Examples are electricity meters and measurements on primary overcurrent protection devices and ripple control units.

---

## Ventilation Requirement

This oscilloscope uses fan to force cooling. Please make sure that the air intake and exhaust areas are free from obstructions and have free air. When using the oscilloscope in a bench-top or rack setting, provide at least 10 cm clearance beside, above and behind the instrument for adequate ventilation.



---

**WARNING**

Inadequate ventilation may cause a temperature increase which can damage the instrument. So please keep the instrument well ventilated during operation and inspect the intake and fan regularly.

---

## Working Environment

### Temperature

Operating: 0°C to +50°C

Non-operating: -40°C to +70°C

### Humidity

0°C to +30°C: ≤95% relative humidity

+30°C to +40°C: ≤75% relative humidity

+40°C to +50°C: ≤45% relative humidity



#### **WARNING**

To avoid short circuits inside the instrument or electric shocks, please do not operate in humid environment.

---

### Altitude

Operating: below 3 km

Non-operating: below 15 km

### Installation (Overvoltage) Category

This product is powered by mains conforming to installation (overvoltage) category II.



#### **WARNING**

Make sure that no overvoltage (such as that produced by a thunderstorm) can reach the product, or else the operator might be exposed to the danger of electric shock.

---

### Installation (Overvoltage) Category Definitions

Installation (overvoltage) category I refers to signal level which is applicable to equipment measurement terminals connected to the source circuit. In these terminals, precautions are done to limit the transient voltage to the corresponding low level.

Installation (overvoltage) category II refers to the local power distribution level which is applicable to equipment connected to the AC line (AC power).

### Pollution Degree

Degree 2

### Pollution Degree Definitions

Pollution degree 1: No pollution or only dry, non-conductive pollution occurs. The pollution has no influence. For example, a clean room or air-conditioned office environment.

Pollution degree 2: Normally only dry, non-conductive pollution occurs. Occasionally a temporary conductivity caused by condensation may occur. For example, general indoor environment.

Pollution degree 3: Conductive pollution occurs, or dry, non-conductive pollution occurs which becomes conductive due to condensation which is expected. For example, sheltered outdoor environment.

Pollution degree 4: Pollution that generates persistent conductivity through conductive dust, rain, or snow. For example, outdoor locations.

**Safety Class**

Class 1 – Grounded Product

## Care and Cleaning

### Care

Do not store or leave the instrument where it may be exposed to direct sunlight for long periods of time.

### Cleaning

Clean the instrument regularly according to its operating conditions.

1. Disconnect the instrument from all power sources.
2. Clean the external surfaces of the instrument with a soft cloth dampened with mild detergent or water. When cleaning the LCD, take care to avoid scarifying it.



#### CAUTION

To avoid damage to the instrument, do not expose it to caustic liquids.

---



#### WARNING

To avoid short-circuit resulting from moisture or personal injuries, ensure that the instrument is completely dry before connecting it to the power supply.

---

## Environmental Considerations

The following symbol indicates that this product complies with the WEEE Directive 2002/96/EC.



### Product End-of-Life Handling

The equipment may contain substances that could be harmful to the environment or human health. To avoid the release of such substances into the environment and avoid harm to human health, we recommend you to recycle this product appropriately to ensure that most materials are reused or recycled properly. Please contact your local authorities for disposal or recycling information.

**From:** RIGOL Technologies Inc

Date: May 5, 2014

156# Cai He Village, Sha He Town, Chang Ping District, Beijing, China

<http://www.rigol.com>

**Declaration of RoHS&WEEE Conformity**

**RoHS:** The European Union of 2011/65/EU Restriction of Hazardous Substances (RoHS) Directive, which applies to all electrical products and their component parts, offered for sale into the European Union after July 22, 2014, restricts the presence of the six substances: Lead (Pb), Cadmium (Cd), Mercury (Hg), Hexavalent Chromium (Cr<sup>6+</sup>), Polybrominated biphenylethers (PBBs), and Polybrominated diphenylethers (PBDEs). In view of legal and market requirements, Rigol has restricted use of Pb, Cd, Hg, Cr<sup>6+</sup>, PBBs, PBDEs in our products. In addition, we require all our direct suppliers to strictly limit or prohibit use of hazardous substances. All its AVL (Approved Vendors List) components apply for RoHS.

**Content of Compliance**

Lead	<0.1% by weight (1000 ppm)	Mercury	<0.1% by weight (1000 ppm)
Cadmium	<0.01% by weight (100 ppm)	Hexavalent Chrome (Cr <sup>6+</sup> )	<0.1% by weight (1000 ppm)
PBBs	<0.1% by weight (1000 ppm)	PBDEs	<0.1% by weight (1000 ppm)

**WEEE:** The European Union of 2012/19/EU, Waste Electrical and Electronic Equipment percentage of reused, recycled and recovered materials, such as metals, plastics, and components of waste electrical and electronic equipment.

We are registered in Germany in the WEEE (in Germany, EAR) register as a manufacturer of category 9 (monitoring and control) equipment and have the assigned registration number

WEEE-Reg.-No. : DE88132002

in our commercial documents.

RIGOL Technologies Inc

Weiming Mao  
 Director of Central Quality and  
 Environmental Management



## MSO1000Z/DS1000Z Series Overview

MSO1000Z/DS1000Z series is a multifunctional and high-performance digital oscilloscope designed on the basis of the UltraVision technique developed by **RIGOL**. Featuring extremely high memory depth, wide dynamic range, clear display, excellent waveform capture rate and comprehensive triggering functions, it is a useful commissioning instrument for various fields such as communication, aerospace, defense, embedded systems, computers, research and education. Wherein, the mixed signal digital oscilloscope aimed at the embedded design and test fields allows users to measure analog and digital signals at the same time. MSO1000Z/DS1000Z is the one with the most comprehensive functions and the most outstanding specifications among the 100 MHz bandwidth digital oscilloscopes.

### Main features:

- 1 GSa/s real-time sample rate of the analog channels; up to 24 Mpts memory depth (optional) and 12 Mpts standard memory depth
- 1 GSa/s real-time sample rate of the digital channels
- 100 MHz, 70 MHz and 50 MHz analog channel bandwidth
- 4 analog channels, 16 digital channels (for MSO1000Z and MSO upgradable for DS1000Z Plus)
- Dual-channel 25 MHz signal source (applicable to digital oscilloscopes with source channels)
- 30 000 wfms/s (dots display) waveform capture rate
- Real-time hardware waveform recording and playback functions; up to 60 000 frames of waveform can be recorded
- MSO field upgradable with MSO1000Z upgrade package (MSO upgrade option, only for DS1000Z Plus)
- Intensity graded color display
- Low base noise, 1 mV/div to 10 V/div ultra-wide vertical dynamic range
- 7.0 inch WVGA (800\*480) TFT LCD, with ultra-wide screen, vivid picture, low power consumption and long service life
- Adjustable waveform brightness
- Auto setting of waveform display (**AUTO**)
- Up to 15 kinds of trigger functions, including various protocol triggers
- Standard parallel decoding, supports multiple serial decoding options
- Auto measurement of 37 waveform parameters (with statistics)
- Fine delayed sweep function
- Built-in FFT function
- Multiple waveform math operation functions
- Pass/fail test function
- Standard interfaces: USB Device, USB Host, LAN and Aux
- Conform to LXI CORE 2011 DEVICE class instrument standards; enable quick, economic and efficient creation and reconfiguration of test system
- Supports remote command control
- Built-in help to facilitate information acquisition



- Supports multiple languages and Chinese/English input
- Novel and delicate industrial design and easy operation

# Document Overview

## Main Topics of this Manual:

### **Chapter 1 Quick Start**

Introduce the preparations before using the oscilloscope and provide a basic introduction of the instrument.

### **Chapter 2 To Set the Vertical System**

Introduce the vertical system functions of the oscilloscope.

### **Chapter 3 To Set the Horizontal System**

Introduce the horizontal system functions of the oscilloscope.

### **Chapter 4 To Set the Sample System**

Introduce the sample system functions of the oscilloscope.

### **Chapter 5 To Trigger the Oscilloscope**

Introduce the trigger mode, trigger coupling, trigger holdoff, external trigger and various trigger types of the oscilloscope.

### **Chapter 6 MATH and Measurement**

Introduce how to make math operation, auto measurement and cursor measurement.

### **Chapter 7 Digital Channel**

Introduce how to use the digital channels of the mixed signal digital oscilloscope.

### **Chapter 8 Protocol Decoding**

Introduce how to decode the input signal using those common protocols.

### **Chapter 9 Reference Waveform**

Introduce how to compare the input waveform with the reference waveform.

### **Chapter 10 Pass/Fail Test**

Introduce how to monitor the input signal using the Pass/Fail test.

### **Chapter 11 Waveform Record**

Introduce how to analyze the input signal using waveform record.

### **Chapter 12 Display Control**

Introduce how to control the display of the oscilloscope.

### **Chapter 13 Signal Source**

Introduce how to use the built-in signal source.

## Chapter 14 Store and Recall

Introduce how to store and recall the measurement result and the setting of the oscilloscope.

## Chapter 15 Accessibility Setting

Introduce how to set the remote interfaces and system-related functions.

## Chapter 16 Remote Control

Introduce how to control the oscilloscope remotely.

## Chapter 17 Troubleshooting

Introduce how to deal with the common failures of the oscilloscope.

## Chapter 18 Specifications

Provide the specifications and general specifications of the oscilloscope.

## Chapter 19 Appendix

Provide common information such as the options and accessories.

## Format Conventions in this Manual:

### 1. Key

The front panel keys are denoted by the format of "Key Name (Bold) + Text Box". For example, **Utility** denotes the "Utility" key.





### 2. Menu

The menu items are denoted by the format of "Menu Word (Bold) + Character Shading". For example, **System** denotes the "System" menu item under **Utility**.

### 3. Operation Step

The next step of operation is denoted by an arrow "→". For example, **Utility** → **System** denotes pressing **Utility** at the front panel and then pressing **System**.

### 4. Knob

Label	Knob
HORIZONTAL  <b>SCALE</b>	Horizontal Scale Knob
HORIZONTAL  <b>POSITION</b>	Horizontal Position Knob
VERTICAL  <b>SCALE</b>	Vertical Scale Knob
VERTICAL  <b>POSITION</b>	Vertical Position Knob
TRIGGER  <b>LEVEL</b>	Trigger Level Knob

**Content Conventions in this Manual:**

MSO1000Z/DS1000Z series includes the following models. Unless otherwise noted, this manual takes MSO1104Z-S for example to illustrate the functions and operation methods of MSO1000Z/DS1000Z series.

Model	Analog Bandwidth	Number of Analog Channels	Number of Source Channels	Number of Digital Channels
MSO1104Z-S	100 MHz	4	2	16
MSO1074Z-S	70 MHz	4	2	16
MSO1104Z	100 MHz	4	--	16
MSO1074Z	70 MHz	4	--	16
DS1104Z-S Plus	100 MHz	4	2	16 <sup>[1]</sup>
DS1074Z-S Plus	70 MHz	4	2	16 <sup>[1]</sup>
DS1104Z Plus	100 MHz	4	--	16 <sup>[1]</sup>
DS1074Z Plus	70 MHz	4	--	16 <sup>[1]</sup>
DS1054Z	50 MHz	4	--	--

**Note**<sup>[1]</sup>: Need to be upgraded to MSO using the MSO upgrade option.

**Manuals of this Product:**

The manuals of this product include the quick guide, user's guide, programming guide, data sheet and etc. The latest versions of the manuals can be downloaded from **RIGOL** official website ([www.rigol.com](http://www.rigol.com)).

# Contents

<b>Guaranty and Declaration .....</b>	<b>I</b>
<b>Safety Requirement .....</b>	<b>II</b>
General Safety Summary.....	II
Safety Notices and Symbols.....	IV
Allgemeine Sicherheits Informationen.....	V
Sicherheits Begriffe und Symbole .....	VII
Measurement Category .....	VIII
Ventilation Requirement .....	IX
Working Environment .....	X
Care and Cleaning .....	XII
Environmental Considerations.....	XII
<b>MSO1000Z/DS1000Z Series Overview .....</b>	<b>XIV</b>
<b>Document Overview.....</b>	<b>XVI</b>
<b>Chapter 1 Quick Start .....</b>	<b>1-1</b>
General Inspection .....	1-2
Appearance and Dimensions.....	1-3
To Prepare the Oscilloscope for Use.....	1-4
To Adjust the Supporting Legs.....	1-4
To Connect to Power Supply.....	1-4
Power-on Inspection .....	1-5
To Connect the Probe.....	1-5
Function Inspection.....	1-7
Probe Compensation .....	1-8
Front Panel Overview.....	1-9
Rear Panel Overview.....	1-10
Front Panel Function Overview.....	1-12
VERTICAL .....	1-12
Logic Analyzer .....	1-13
Signal Source .....	1-13
HORIZONTAL .....	1-14
TRIGGER .....	1-15
CLEAR .....	1-15
AUTO.....	1-15
RUN/STOP .....	1-16
SINGLE .....	1-16
Multifunction Knob .....	1-16
Function Menus .....	1-17
Print .....	1-18
User Interface.....	1-19
Parameter Setting Method.....	1-24
To Use the Security Lock .....	1-25

To Use the Built-in Help System.....	1-26
<b>Chapter 2 To Set the Vertical System.....</b>	<b>2-1</b>
To Enable the Analog Channel .....	2-2
Channel Coupling .....	2-2
Bandwidth Limit .....	2-3
Probe Ratio .....	2-3
Waveform Invert .....	2-4
Vertical Scale .....	2-4
Amplitude Unit .....	2-5
Channel Label.....	2-5
Delay Calibration of the Analog Channel .....	2-7
<b>Chapter 3 To Set the Horizontal System .....</b>	<b>3-1</b>
Delayed Sweep .....	3-2
Time Base Mode .....	3-3
YT Mode .....	3-3
XY Mode .....	3-3
Roll Mode .....	3-5
<b>Chapter 4 To Set the Sample System .....</b>	<b>4-1</b>
Acquisition Mode .....	4-2
Normal .....	4-2
Peak Detect .....	4-2
Average .....	4-2
High Resolution .....	4-3
Sin(x)/x.....	4-4
Sample Rate .....	4-4
Memory Depth.....	4-6
Antialiasing.....	4-7
<b>Chapter 5 To Trigger the Oscilloscope.....</b>	<b>5-1</b>
Trigger Source .....	5-2
Trigger Mode .....	5-3
Trigger Coupling.....	5-4
Trigger Holdoff.....	5-5
Noise Rejection .....	5-5
Trigger Type .....	5-6
Edge Trigger .....	5-7
Pulse Trigger .....	5-8
Slope Trigger.....	5-10
Video Trigger.....	5-13
Pattern Trigger .....	5-15
Duration Trigger .....	5-17
TimeOut Trigger (Optional).....	5-19
Runt Trigger (Optional) .....	5-21
Window Trigger (Optional).....	5-23
Delay Trigger (Optional) .....	5-25

Setup/Hold Trigger (Optional) .....	5-28
Nth Edge Trigger (Optional) .....	5-30
RS232 Trigger (Optional) .....	5-32
I2C Trigger (Optional) .....	5-34
SPI Trigger (Optional) .....	5-37
Trigger Output Connector .....	5-39
<b>Chapter 6 MATH and Measurement .....</b>	<b>6-1</b>
Math Operation .....	6-2
Addition .....	6-2
Subtraction .....	6-3
Multiplication .....	6-4
Division .....	6-4
FFT .....	6-6
"AND" Operation .....	6-11
"OR" Operation .....	6-12
"XOR" Operation .....	6-13
"NOT" Operation .....	6-14
Intg .....	6-15
Diff .....	6-16
Sqrt .....	6-17
Lg (Use 10 as the Base) .....	6-17
Ln .....	6-18
Exp .....	6-19
Abs .....	6-20
Filter .....	6-21
Fx Operation .....	6-22
Math Operation Label .....	6-23
Auto Measurement .....	6-24
Quick Measurement after AUTO .....	6-24
One-key Measurement of 37 Parameters .....	6-25
Frequency Counter Measurement .....	6-31
Measurement Setting .....	6-31
To Clear the Measurement .....	6-32
All Measurement .....	6-34
Statistic Function .....	6-34
Measurement History .....	6-35
Measurement Result Display Type .....	6-35
Cursor Measurement .....	6-36
Manual Mode .....	6-36
Track Mode .....	6-40
Auto Mode .....	6-42
XY Mode .....	6-43
<b>Chapter 7 Digital Channel .....</b>	<b>7-1</b>
To Select the Digital Channel .....	7-2
To Turn on/off the Digital Channel .....	7-2

Group Set.....	7-3
To Set the Waveform Display Size .....	7-4
Reorder Setting.....	7-4
Auto View.....	7-4
To Set the Threshold .....	7-4
To Set the Label.....	7-5
Probe Calibration.....	7-5
Digital Channel Delay Calibration .....	7-5
<b>Chapter 8 Protocol Decoding .....</b>	<b>8-1</b>
Parallel Decoding .....	8-2
RS232 Decoding (Optional) .....	8-7
I2C Decoding (Optional) .....	8-12
SPI Decoding (Optional) .....	8-15
<b>Chapter 9 Reference Waveform .....</b>	<b>9-1</b>
To Enable REF Function .....	9-2
To Select REF Source.....	9-2
To Adjust REF Waveform Display .....	9-2
To Save to Internal Memory .....	9-2
To Set the Color .....	9-3
To Reset the Reference Waveform .....	9-3
To Export to Internal or External Memory .....	9-3
To Import from Internal or External Memory .....	9-3
<b>Chapter 10 Pass/Fail Test.....</b>	<b>10-1</b>
To Enable Pass/Fail Test.....	10-2
To Select Source .....	10-2
Mask Range.....	10-2
Test and Output.....	10-3
To Save the Test Mask.....	10-4
To Load the Test Mask.....	10-4
<b>Chapter 11 Waveform Record.....</b>	<b>11-1</b>
Common Settings.....	11-2
Playback Option .....	11-3
Record Option.....	11-4
<b>Chapter 12 Display Control .....</b>	<b>12-1</b>
To Select the Display Type .....	12-2
To Set the Persistence Time .....	12-2
To Set the Waveform Intensity .....	12-3
To Set the Screen Grid.....	12-3
To Set the Grid Brightness.....	12-3
<b>Chapter 13 Signal Source .....</b>	<b>13-1</b>
To Output Basic Waveform .....	13-2
To Output Sine .....	13-2
To Output Square .....	13-3



To Output Ramp .....	13-4
To Output Pulse .....	13-5
To Output DC .....	13-5
To Output Noise.....	13-6
To Output Built-in Waveform.....	13-6
To Output Arbitrary Waveform .....	13-10
To Select Waveform .....	13-11
To Create Waveform.....	13-12
To Edit Waveform .....	13-14
Modulation .....	13-15
AM .....	13-16
FM .....	13-17
<b>Chapter 14    Store and Recall.....</b>	<b>14-1</b>
Storage System.....	14-2
Storage Type .....	14-2
Internal Storage and Recall .....	14-5
External Storage and Recall.....	14-6
Disk Management.....	14-7
To Select File Type .....	14-7
To Create a New File or Folder .....	14-8
To Delete a File or Folder .....	14-11
To Rename a File or Folder .....	14-11
To Clear the Local Memory.....	14-11
Factory.....	14-12
<b>Chapter 15    Accessibility Setting.....</b>	<b>15-1</b>
Remote Interface Configuration .....	15-2
LAN Configuration.....	15-2
USB Device .....	15-5
System-related.....	15-6
Sound.....	15-6
Language.....	15-6
System Information.....	15-6
Vertical Reference .....	15-6
Power-off Recall.....	15-7
Self-calibration.....	15-7
Print Setting .....	15-8
Aux Output .....	15-10
Option Management.....	15-11
Auto Options .....	15-12
Key Lock .....	15-12
<b>Chapter 16    Remote Control.....</b>	<b>16-1</b>
Remote Control via USB .....	16-2
Remote Control via LAN .....	16-6
<b>Chapter 17    Troubleshooting.....</b>	<b>17-1</b>

---

<b>Chapter 18</b>	<b>Specifications .....</b>	<b>18-1</b>
<b>Chapter 19</b>	<b>Appendix .....</b>	<b>19-1</b>
	Appendix A: Accessories and Options .....	19-1
	Appendix B: Warranty.....	19-2
<b>Index.....</b>		<b>1</b>

# Chapter 1 Quick Start

This chapter introduces the precautions when using the oscilloscope for the first time, the front/rear panels of the oscilloscope, the user interface and the using method of the built-in help system.

The contents of this chapter:

- General Inspection
- Appearance and Dimensions
- To Prepare the Oscilloscope for Use
- Front Panel Overview
- Rear Panel Overview
- Front Panel Function Overview
- User Interface
- Parameter Setting Method
- To Use the Security Lock
- To Use the Built-in Help System

## General Inspection

### 1. Inspect the packaging

If the packaging has been damaged, do not dispose the damaged packaging or cushioning materials until the shipment has been checked for completeness and has passed both electrical and mechanical tests.

The consigner or carrier shall be liable for the damage to the instrument resulting from shipment. **RIGOL** would not be responsible for free maintenance/rework or replacement of the instrument.

### 2. Inspect the instrument

In case of any mechanical damage, missing parts, or failure in passing the electrical and mechanical tests, contact your **RIGOL** sales representative.

### 3. Check the accessories

Please check the accessories according to the packing lists. If the accessories are damaged or incomplete, please contact your **RIGOL** sales representative.

# Appearance and Dimensions

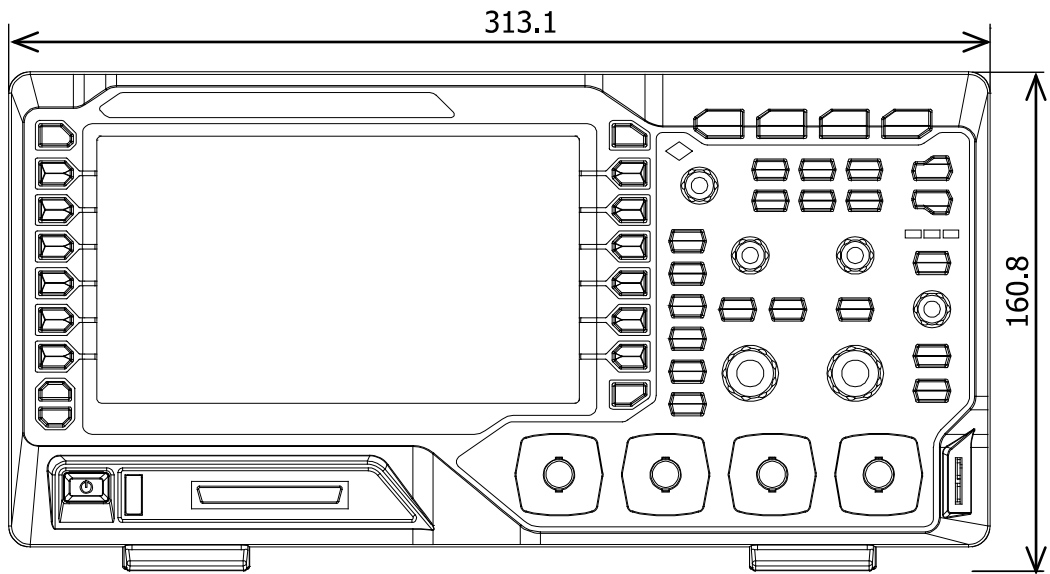

Figure 1-1 Front View

Unit: mm

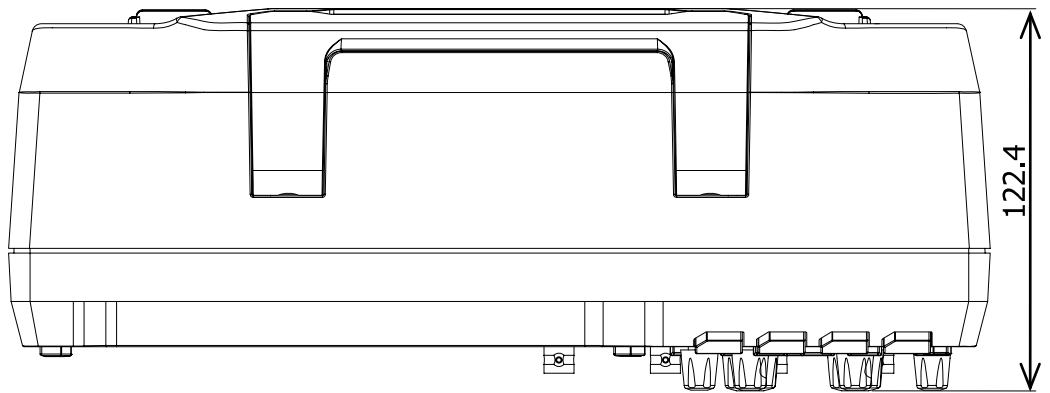

Figure 1-2 Top View

Unit: mm

## To Prepare the Oscilloscope for Use

### To Adjust the Supporting Legs

Adjust the supporting legs properly to use them as stands to tilt the oscilloscope upwards for stable placement of the oscilloscope as well as better operation and observation.

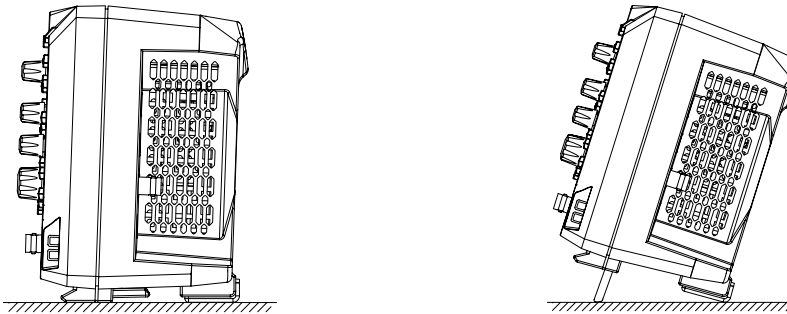

Figure 1-3 To Adjust the Supporting Legs

### To Connect to Power Supply

The power requirements of the oscilloscope are 100-240 V, 45-440 Hz. Please use the power cord supplied with the accessories to connect the oscilloscope to the AC power source as shown in the figure below.

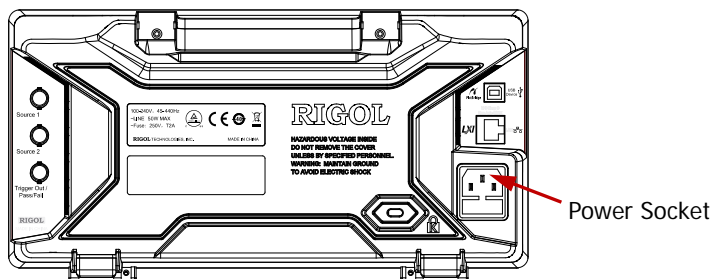



Figure 1-4 To Connect to Power Supply

## Power-on Inspection

When the oscilloscope is energized, pressing the power key  at the lower-left corner of the front panel can start the oscilloscope. During the start-up process, the oscilloscope performs a series of self-tests. After the self-test, the welcome screen is displayed. The instrument is installed with the trial versions of the options before leaving factory and the remaining trial time is about 2000 minutes. The "Current Options" dialog box will be displayed if your instrument currently installs the trial versions of options. From this dialog box you can view the name, detail, version and remaining trial time of the option currently installed.

## To Connect the Probe

**RIGOL** provides passive probe (standard) for DS1000Z series as well as passive probe (standard) and logic probe (standard) for MSO1000Z series. For detailed technical information of the probes, please refer to the corresponding Probe User's Guide.

### Connect the passive probe:

1. Connect the BNC terminal of the probe to an analog channel input terminal of the oscilloscope at the front panel.
2. Connect the ground alligator clip or spring of the probe to the circuit ground terminal and connect the probe tip to the circuit point to be tested.

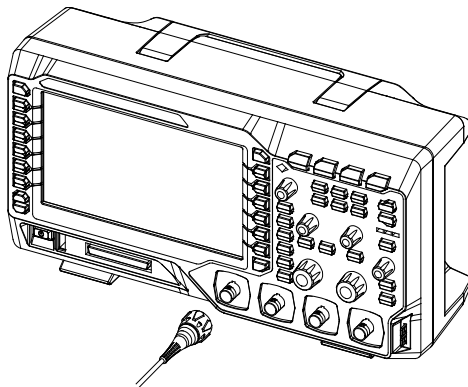

Figure 1-5 To Connect the Passive Probe

**Connect the logic probe:**

1. Connect the single-wire terminal of the logic probe to the digital channel input terminal at the front panel of the oscilloscope in the correct direction.
2. Connect the signal under test to the other terminal of the logic probe. MSO1000Z series is provided with the RPL1116 logic probe (standard) which provides two connecting methods to connect the signal under test to realize convenient and flexible detection. For the details, please refer to the *RPL1116 Logic Probe User's Guide*.



Figure 1-6 To Connect the Logic Probe

**Note:** The digital channel input terminal does not support hot plug. Please do not insert or pull out the logic probe when the instrument is powered on.



## Function Inspection

1. Press **Storage** → **Default** to restore the oscilloscope to its default configuration.
2. Connect the earth alligator clip of the probe to the "Ground Terminal" as shown in the figure below.
3. Use the probe to connect the input terminal of CH1 of the oscilloscope and the "Compensation Signal Output Terminal" of the probe.

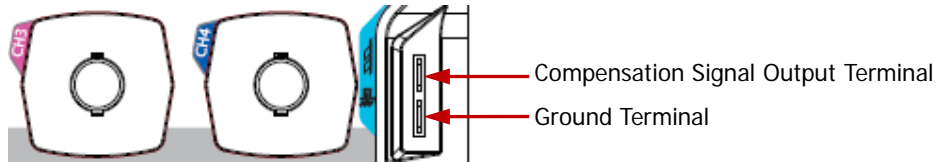

Figure 1-7 To Use the Compensation Signal

4. Set the attenuation on the probe to 10X. Then press **AUTO**.
5. Observe the waveform on the display. In normal condition, the square waveform as shown in the figure below should be displayed.

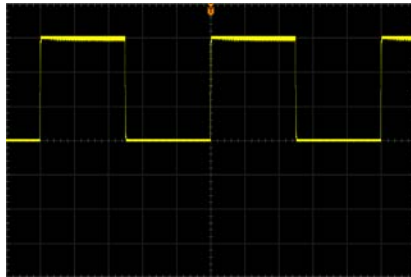

Figure 1-8 Square Waveform

6. Use the same method to test the other channels. If the square waveforms actually shown do not match that in the figure above, please perform "**Probe Compensation**".



### WARNING

To avoid electric shock when using the probe, please make sure that the insulated wire of the probe is in good condition and do not touch the metallic part of the probe when the probe is connected to high voltage source.

### Tip

The signal output from the probe compensation connector can only be used for probe compensation adjustment and can not be used for calibration.

## Probe Compensation

When the probes are used for the first time, you should compensate the probes to make them match the input channels of the oscilloscope. Non-compensated or poorly compensated probes may cause measurement inaccuracy or error. The probe compensation procedures are as follows.

1. Perform steps 1, 2, 3 and 4 of "**Function Inspection**".
2. Check the displayed waveforms and compare them with the following figures.

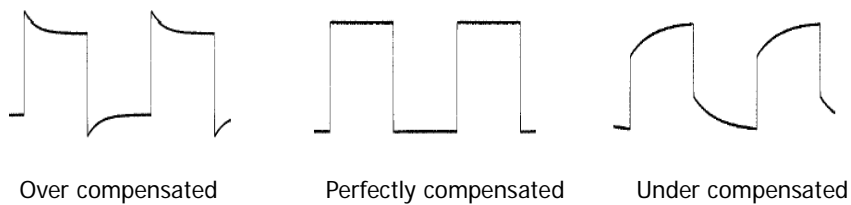

Figure 1-9 Probe Compensation

3. Use a nonmetallic driver to adjust the low-frequency compensation adjustment hole on the probe until the displayed waveform is as the "Perfectly compensated" in the figure above.

## Front Panel Overview

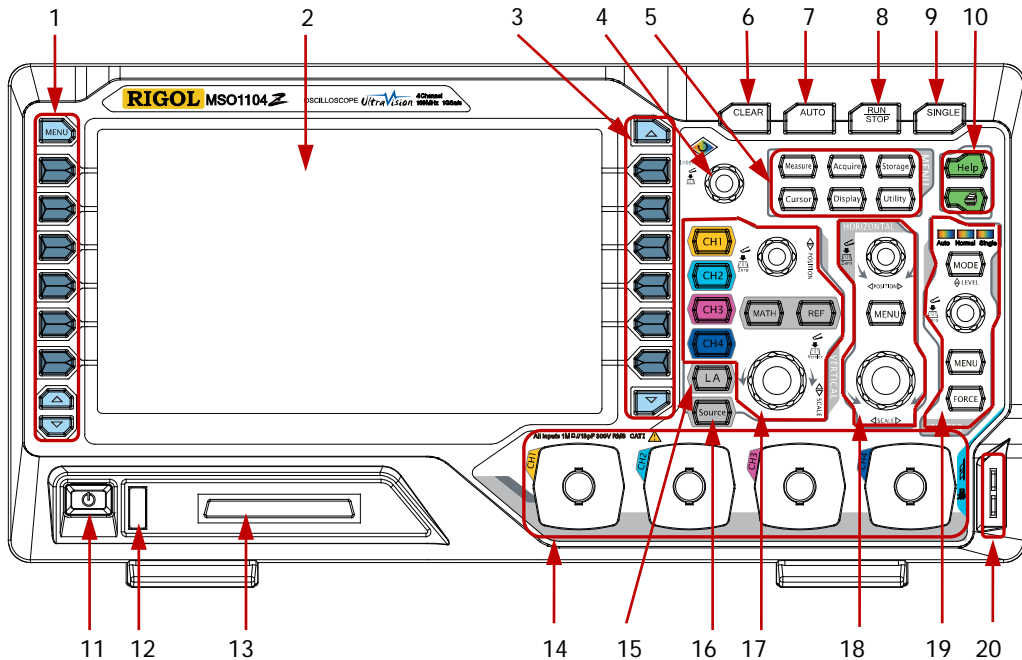

Figure 1-10 Front Panel Overview

Table 1-1 Front Panel Descriptions

No.	Description	No.	Description
1	Measurement Menu Softkeys	11	Power Key
2	LCD	12	USB Host Interface
3	Function Menu Softkeys	13	Digital Channel Input Interface <sup>[1]</sup>
4	Multifunction Knob	14	Analog Channel Input Interface
5	Common Operation Keys	15	Logic Analyzer Control Key <sup>[1]</sup>
6	CLEAR	16	Signal Source <sup>[2]</sup>
7	AUTO	17	VERTICAL Control
8	RUN/STOP	18	HORIZONTAL Control
9	SINGLE	19	TRIGGER Control
10	Help/Print	20	Probe Compensation Signal Output Terminal/Ground Terminal

**Note<sup>[1]</sup>:** Only applicable to MSO1000Z and DS1000Z Plus.

**Note<sup>[2]</sup>:** Only applicable to digital oscilloscopes with source channels.

# Rear Panel Overview

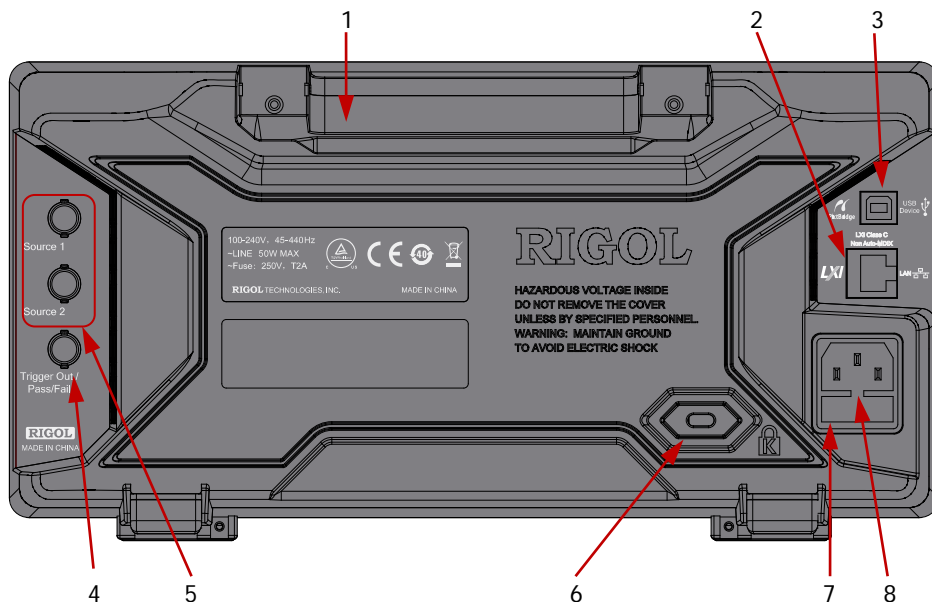

Figure 1-11 Rear Panel Overview

1. **Handle**  
 Pull up the handle vertically for easy carry of the instrument. When you do not need the handle, press it down.
2. **LAN**  
 Connect the instrument to network via this interface for remote control. This oscilloscope conforms to the LXI CORE 2011 DEVICE class instrument standards and can quickly build test system with other instruments.
3. **USB Device**  
 You can connect the oscilloscope to a PictBridge printer or PC via this interface. When a PC is connected, users can send SCPI commands using the PC software or control the oscilloscope via user-defined programming. When a printer is connected, users can print the waveform displayed on the screen using the printer.
4. **Trigger Out and Pass/Fail**
  - **Trigger Out:**  
 The oscilloscope can output a signal that can reflect the current capture rate of the oscilloscope at each trigger via this interface. Connect the signal to a waveform display device and measure the frequency of the signal. The measurement result is the same with the current capture rate.

- **Pass/Fail:**

The instrument can output a negative pulse via this connector when a failed waveform is detected during the pass/fail test. The instrument continuously outputs a low level via this connector when no failed waveform is detected.

## 5. Source Output

The output terminals of the built-in dual-channel source of the oscilloscope. When source 1 or source 2 is enabled, the signal currently set can be output through the **[Source 1]** or **[Source 2]** connector at the rear panel.

## 6. Lock Hole

You can lock the instrument to a fixed location using the security lock (please buy it yourself) via the lock hole.

## 7. Fuse

If a new fuse is required, please use the specified fuse (250V, T2A). The replacing method is as follows.

- a) Turn off the instrument, switch off the power supply and remove the power cord.
- b) Insert a small straight screwdriver into the slot at the power socket and pry out the fuse seat gently.
- c) Take out the fuse and replace it with a specified fuse. Then, install the fuse seat.

## 8. AC Power Socket

AC power input terminal. The power requirements of this oscilloscope are 100-240 V, 45-440 Hz. Use the power cord provided with the accessories to connect the instrument to AC power. Then, you can press the power key at the front panel to start the instrument.

# Front Panel Function Overview

## VERTICAL

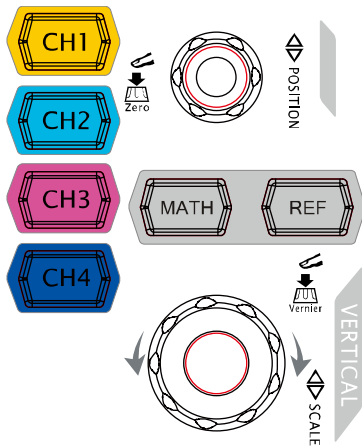

**CH1**, **CH2**, **CH3**, **CH4**: analog channel setting keys. The 4 channels are marked by different colors which are also used to mark both the corresponding waveforms on the screen and the channel input connectors. Press any key to open the corresponding channel menu and press again to turn off the channel.

**MATH**: press **MATH** → **Math** to open the math operation menu under which  $A+B$ ,  $A-B$ ,  $A \times B$ ,  $A/B$ , FFT,  $A \& \& B$ ,  $A || B$ ,  $A^B$ ,  $!A$ , Intg, Diff, Sqrt, Lg, Ln, Exp, Abs and Filter operations are provided. You can also press **MATH** to open the decoding menu and set the decoding options.

**REF**: press this key to enable the reference waveform function to compare the waveform actually measured with the reference waveform.

**VERTICAL** **POSITION**: modify the vertical position of the current channel waveform. Turn clockwise to increase the position and turn counterclockwise to decrease. During the modification, the waveform would move up and down and the position message (e.g. **POS: 216.0mV**) at the lower-left corner of the screen would change accordingly. Press down this knob to quickly reset the vertical position to zero.

**VERTICAL** **SCALE**: modify the vertical scale of the current channel. Turn clockwise to decrease the scale and turn counterclockwise to increase. During the modification, the display amplitude of the waveform would enlarge or reduce. The scale information (e.g. **1 = 200mV**) at the lower side of the screen would change accordingly. Press down this knob to quickly switch the vertical scale adjustment mode between "Coarse" and "Fine".

### Tip

#### How to set the vertical scale and vertical position of each channel?

The 4 channels of MSO1000Z/DS1000Z use the same **VERTICAL** **POSITION** and **VERTICAL** **SCALE** knobs. If you want to set the vertical scale and vertical position of a channel, please press **CH1**, **CH2**, **CH3** or **CH4** at first to select the desired channel. Then turn the **VERTICAL** **POSITION** and **VERTICAL** **SCALE** knobs to set the values.

## Logic Analyzer



Press this key to open the logic analyzer control menu. You can turn on or off any channel or channel group, modify the display size of the digital channel, modify the logic threshold of the digital channel as well as group the 16 digital channels. You can also set a label for each digital channel.

### Note:

- This function is only applicable to MSO1000Z and DS1000Z Plus with the MSO upgrade option.
- Press **LA** → **D7-D0**; when "On" is selected, CH4 function is automatically disabled; when "Off" is selected, CH4 function recovers automatically. Press **LA** → **D15-D8**; when "On" is selected, CH3 function is automatically disabled; when "Off" is selected, CH3 function recovers automatically.

## Signal Source



Press this key to enter the source setting interface. You can enable or disable the output of the **[Source 1]** or **[Source 2]** connector at the rear panel, set the output signal waveform and parameters, turn on or off the state display of the current signal.

**Note:** This function is only applicable to digital oscilloscopes with source channels.

# HORIZONTAL

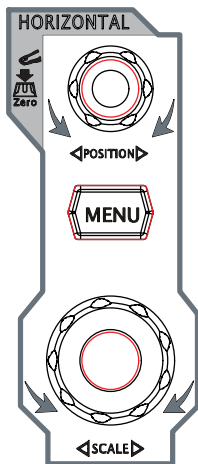

**HORIZONTAL POSITION:** modify the horizontal position. The trigger point would move left or right relative to the center of the screen when you turn the knob. During the modification, waveforms of all the channels would move left or right and the horizontal position message (e.g. **D -200.000000ns**) at the upper-right corner of the screen would change accordingly. Press down this knob to quickly reset the horizontal position (or the delayed sweep position).

**MENU:** press this key to open the horizontal control menu where you can turn on or off the delayed sweep function and switch between different time base modes.

**HORIZONTAL SCALE:** modify the horizontal time base. Turn clockwise to reduce the time base and turn counterclockwise to increase the time base. During the modification, waveforms of all the channels will be displayed in expanded or compressed mode and the time base message (e.g. **H 500ns**) at the upper side of the screen would change accordingly. Press down this knob to quickly switch to the delayed sweep state.



## TRIGGER

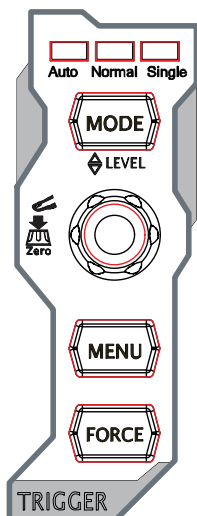

**MODE**: press this key to switch the trigger mode to **Auto**, **Normal** or **Single** and the corresponding state backlight of the current trigger mode would be illuminated.

**TRIGGER LEVEL**: modify the trigger level. Turn clockwise to increase the level and turn counterclockwise to reduce the level. During the modification, the trigger level line would move up and down and the value in the trigger level message box (e.g. `Trig Level : 428mV`) at the lower-left corner of the screen would change accordingly. Press down the knob to quickly reset the trigger level to zero point.

**MENU**: press this key to open the trigger operation menu. This oscilloscope provides various trigger types. For more details, please refer to "**To Trigger the Oscilloscope**".

**FORCE**: press this key to generate a trigger signal forcefully.

## CLEAR



Press this key to clear all the waveforms on the screen. If the oscilloscope is in the "RUN" state, new waveforms will be displayed.

## AUTO

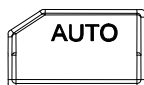

Press this key to enable the waveform auto setting function. The oscilloscope will automatically adjust the vertical scale, horizontal time base and trigger mode according to the input signal to realize optimum waveform display.

**Note:** Waveform auto setting function requires that the frequency of sine is no lower than 41 Hz; the duty cycle should be greater than 1% and the amplitude must be at least 20 mVpp for square. Otherwise, the Waveform auto setting function may be invalid and the quick parameter measurement function displayed in the menu will also be unavailable.

## RUN/STOP



Press this key to "RUN" or "STOP" waveform sampling. In the "RUN" state, the key is illuminated in yellow. In the "STOP" state, the key is illuminated in red.

## SINGLE

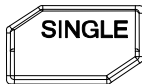

Press this key to set the trigger mode to "Single". In single trigger mode, press **FORCE** to generate a trigger signal immediately.

## Multifunction Knob



### Adjust waveform brightness:

In non-menu-operation mode, turn this knob to adjust the brightness of waveform display. The adjustable range is from 0% to 100%. Turn clockwise to increase the brightness and counterclockwise to reduce. Press down this knob to reset the brightness to 60%.

You can also press **Display** → **WaveIntensity** and use the knob to adjust the waveform brightness.

### Multifunction:

In menu operation, the backlight of the knob goes on. Press any menu softkey and turn the knob to select the submenus under this menu and then press down the knob to select the current submenu. It can also be used to modify parameters (please refer to the introduction in "**Parameter Setting Method**") and input filename.

## Function Menus

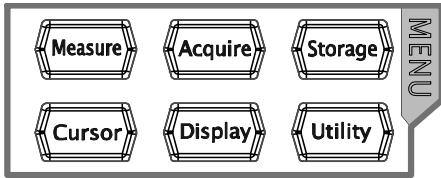

**Measure**: press this key to open the measurement setting menu. You can set the measurement source, turn on or off the frequency counter, all measure, statistic function and etc. Press **MENU** at the left of the screen to open the measurement menus of 37 waveform parameters. Then, press down the corresponding menu softkey to quickly realize one-key measurement and the measurement result will be displayed at the bottom of the screen.

**Acquire**: press this key to enter the sample setting menu to set the acquisition mode,  $\text{Sin}(x)/x$  and memory depth of the oscilloscope.

**Storage**: press this key to enter the file store and recall interface. The storable file types include picture, traces, waves, setups, CSV and parameters. Internal and external storage as well as disk management are also supported.

**Cursor**: press this key to enter the cursor measurement menu. The oscilloscope provides four cursor modes: manual, track, auto and XY. Note that XY cursor mode is only available when the horizontal time base is set to XY.

**Display**: press this key to enter the display setting menu to set the display type, persistence time, wave intensity, grid type and grid brightness.

**Utility**: press this key to enter the system function setting menu to set the system-related functions or parameters, such as the I/O, sound and language. Besides, some advanced functions (such as the pass/fail test, waveform record, etc.) are also supported.

## Print

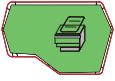

Press this key to print the screen or save the screen to a USB storage device.

- If a PictBridge printer is connected currently and the printer is in idle state, pressing this key will execute the print operation.
- If no printer is connected but a USB storage device is inserted, pressing this key can save the screen to the USB storage device in the specified format. For more details, please refer to the introduction in "**Storage Type**".
- If both a printer and a USB storage device are connected at the same time, the printer enjoys higher priority when pressing this key.

**Note:** MSO1000Z/DS1000Z only supports the flash memory USB storage device of FAT32 format.

## User Interface

MSO1000Z/DS1000Z provides 7.0 inch WVGA (800\*480) TFT LCD.

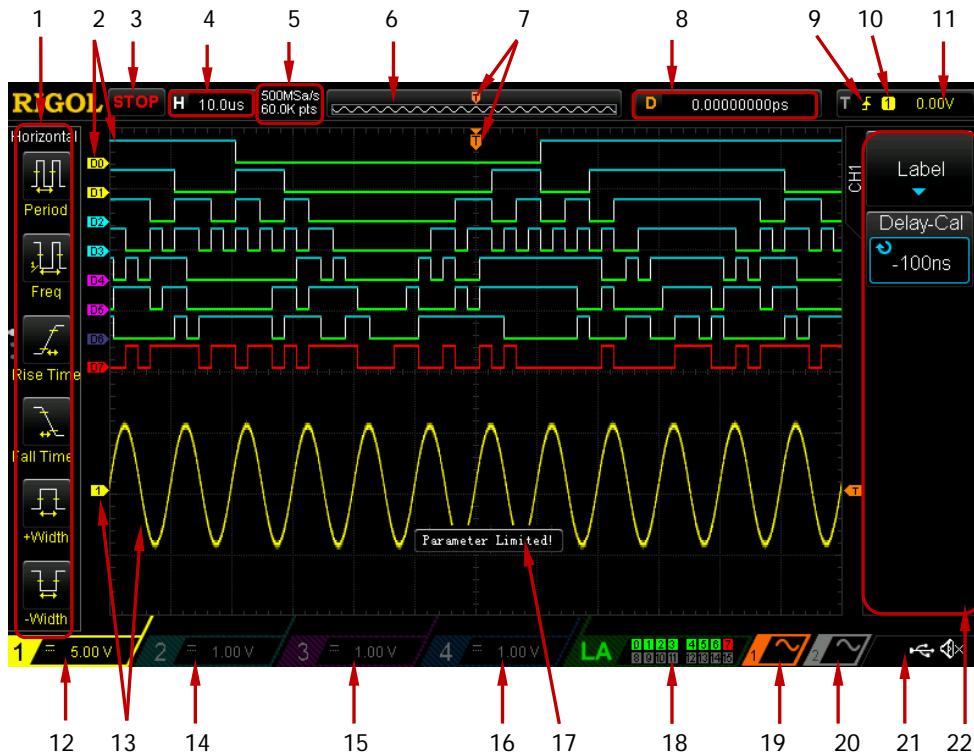

Figure 1-12 User Interface

### 1. Auto Measurement Items

Provide 20 horizontal (HORIZONTAL) and 17 vertical (VERTICAL) measurement parameters. Press the softkey at the left of the screen to activate the corresponding measurement item. Press **MENU** continuously to switch between the horizontal and vertical parameters.

### 2. Digital Channel Label/Waveform

The logic high level of the digital waveform is displayed in blue and the logic low level in green. Its edge is displayed in white. The waveform of the digital channel currently selected and the channel label are displayed in red. The digital channels can be divided into 4 channel groups by the grouping setting function of the logic analyzer function menu. The channel labels of the same channel group are displayed in the same color; different channel groups are marked with different colors.

**Note:** This function is only applicable to MSO1000Z and DS1000Z Plus with the MSO upgrade option.

### 3. Status

Available states include RUN, STOP, T'D (triggered), WAIT and AUTO.

### 4. Horizontal Time Base

- Represent the time per grid on the horizontal axis on the screen.
- Use **HORIZONTAL**  **SCALE** to modify this parameter. The range available is from 5 ns to 50 s.

### 5. Sample Rate/Memory Depth

- Display the current sample rate and memory depth of the oscilloscope.
- The sample rate and memory depth will change in accordance with the horizontal time base.

### 6. Waveform Memory

Provide the schematic diagram of the memory position of the waveform currently on the screen.

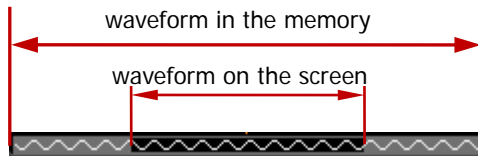

### 7. Trigger Position

Display the trigger position of the waveform in the waveform memory and on the screen.

### 8. Horizontal Position

Use **HORIZONTAL**  **POSITION** to modify this parameter. Press down the knob to automatically set the parameter to zero.



### 9. Trigger Type



Display the currently selected trigger type and trigger condition setting. Different labels are displayed when different trigger types are selected. For example,  represents triggering on the rising edge in "Edge" trigger.

### 10. Trigger Source



Display the trigger source currently selected (CH1-CH4, AC or D0-D15). Different labels are displayed when different trigger sources are selected and the color of the trigger parameter area will change accordingly. For example,  denotes that CH1 is selected as the trigger source.

## 11. Trigger Level

- When an analog channel is selected as the trigger source, you need to set a proper trigger level.
- The trigger level label  is displayed at the right of the screen and the trigger level value is displayed at the upper-right corner of the screen.
- When using **TRIGGER**  **LEVEL** to modify the trigger level, the trigger level value will change with the up and down of .

**Note:** In slope trigger, runt trigger and window trigger, two trigger level labels ( and ) are displayed.



## 12. CH1 Vertical Scale

- Display the voltage value per grid of CH1 waveform vertically.
- Press **CH1** to select CH1, and use **VERTICAL**  **SCALE** to modify this parameter.
- The following labels will be displayed according to the current channel setting: channel coupling (e.g. ) and bandwidth limit (e.g. )



## 13. Analog Channel Label/Waveform

Different channels are marked with different colors and the colors of the channel label and waveform are the same.



## 14. CH2 Vertical Scale

- Display the voltage value per grid of CH2 waveform vertically.
- Press **CH2** to select CH2, and use **VERTICAL**  **SCALE** to modify this parameter.
- The following labels will be displayed according to the current channel setting: channel coupling (e.g. ) and bandwidth limit (e.g. )

## 15. CH3 Vertical Scale

- Display the voltage value per grid of CH3 waveform vertically.
- Press **CH3** to select CH3, and use **VERTICAL**  **SCALE** to modify this parameter.
- The following labels will be displayed according to the current channel setting: channel coupling (e.g. ) and bandwidth limit (e.g. )

## 16. CH4 Vertical Scale

- Display the voltage value per grid of CH4 waveform vertically.
- Press **CH4** to select CH4, and use **VERTICAL**  **SCALE** to modify this parameter.
- The following labels will be displayed according to the current channel setting: channel coupling (e.g. ) and bandwidth limit (e.g. )

## 17. Message Box



Display the prompt messages.

## 18. Digital Channel Status Area



Display the current status of the 16 digital channels. The digital channels currently turned on are displayed in green and the digital channel currently selected is displayed in red. The digital channels turned off are displayed in grey.

**Note:** This function is only applicable to MSO1000Z and DS1000Z Plus with the MSO upgrade option.

## 19. Source 1 Waveform



- Display the type of waveform currently set for source 1.
- When the modulation of source 1 is enabled,  will be displayed below the source 1 waveform.
- When the impedance of source 1 is set to 50 Ω,  will be displayed below the source 1 waveform.
- This function is only applicable to digital oscilloscopes with source channels.

## 20. Source 2 Waveform

- Display the type of waveform currently set for source 2.
- When the modulation of source 2 is enabled,  will be displayed below the source 2 waveform.
- When the impedance of source 2 is set to 50 Ω,  will be displayed below the source 2 waveform.
- This function is only applicable to digital oscilloscopes with source channels.











## 21. Notification Area

Display the sound icon and USB storage device icon.





- Sound Icon: Press **Utility** → **Sound** to enable or disable the sound. When the sound is enabled,  will be displayed; when the sound is disabled,  will be displayed.
- USB Storage Device Icon: when a USB storage device is detected,  will be displayed.

## 22. Operation Menu

Press any softkey to activate the corresponding menu. The following symbols might be displayed in the menu:

-  Denote that the multifunction knob  can be used to modify the parameters. The backlight of  turns on in the parameter modification status.
-  Denote that you can use  to select the desired items and the item currently selected is displayed in blue. Press down  to enter the menu bar corresponding to the selected item. The backlight of  is constant on after menus with this symbol are selected.
-  Denote that you can press  to open the pop-up numeric keyboard and input the desired parameter values directly. The backlight of  is constant on after menus with this symbol are selected.





-  Denote that the current menu has several options.
-  Denote that the current menu has a lower level menu.
-  Press this key to return to the previous menu.
-  The number of dots indicates the number of pages of the current menu.

## Parameter Setting Method

MSO1000Z/DS1000Z supports the following two parameter setting methods.

Method one:

For the parameters with  displayed on the menu, you can turn the multifunction knob  directly to set the desired values.

Method two:



For the parameters with  displayed on the menu, press down the multifunction knob  and the numeric keyboard as shown in the figure below is displayed. Turn the knob to select the desired value and press down the knob to input the value. After entering all the values, turn the knob to select the desired unit and press down the knob to complete the parameter setting.



Figure 1-13 Numeric Keyboard

## To Use the Security Lock

If needed, you can use the security lock (please buy it yourself) to lock the oscilloscope to a fixed location. The method is as follows, align the lock with the lock hole and plug it into the lock hole vertically, turn the key clockwise to lock the oscilloscope and then pull the key out.

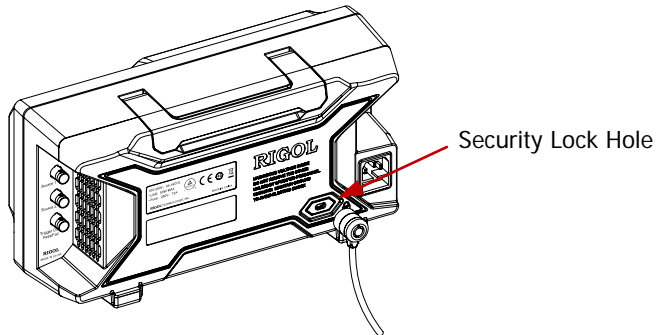

Figure 1-14 To Use the Security Lock

**Note:** Please do not insert other articles into the security lock hole to avoid damaging the instrument.

## To Use the Built-in Help System

The help system of this oscilloscope provides instructions for all the function keys (including the menu keys) at the front panel. Press **Help** to open the help interface and press again to close the interface. The help interface mainly consists of two parts. The left are "Help Options". The right is the "Help Display Area".

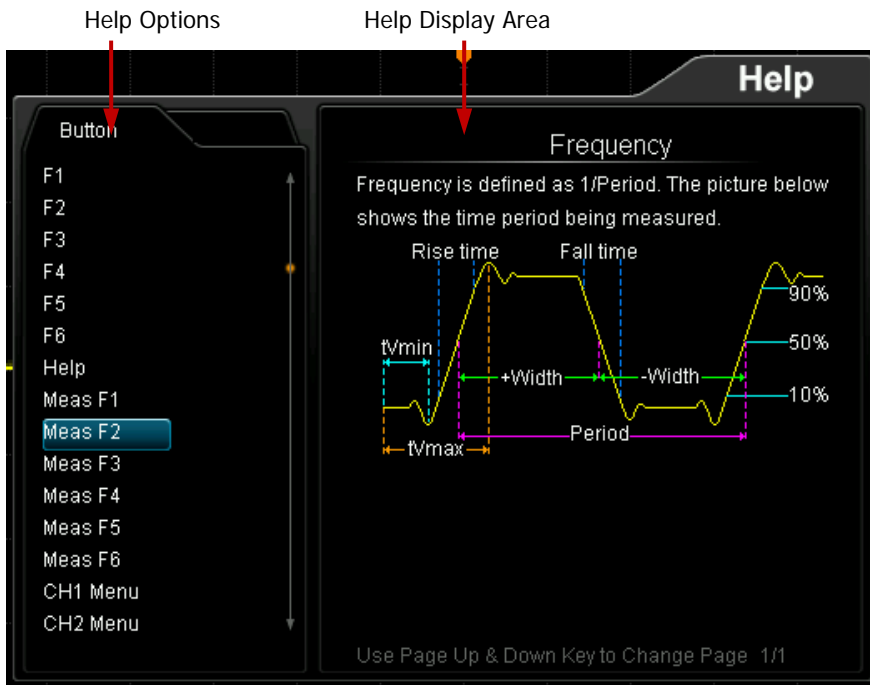





Figure 1-15 Help Interface

You can press the button (except the power key , the multifunction knob  and the menu page up/down key ) directly at the front panel to get the corresponding help information in the "Help Display Area".

## Chapter 2 To Set the Vertical System

The contents of this chapter:

- To Enable the Analog Channel
- Channel Coupling
- Bandwidth Limit
- Probe Ratio
- Waveform Invert
- Vertical Scale
- Amplitude Unit
- Channel Label
- Delay Calibration of the Analog Channel

## To Enable the Analog Channel

MSO1000Z/DS1000Z provides 4 analog input channels (CH1-CH4). As the setting methods of the vertical systems of the four channels are the same, this chapter takes CH1 as an example to illustrate the setting method of the vertical system.

Connect a signal to the channel connector of CH1 and then press **CH1** in the vertical control area (VERTICAL) at the front panel to enable CH1. At this point, the channel setting menu is displayed at the right side of the screen and the channel status label at the bottom of the screen (as shown in the figure below) is highlighted. The information displayed in the channel status label is related to the current channel setting.



After the channel is turned on, modify the parameters such as the vertical scale, horizontal time base, trigger mode and trigger level according to the input signal for easy observation and measurement of the waveform.

## Channel Coupling

The undesired signals can be filtered out by setting the coupling mode. For example, the signal under test is a square waveform with DC offset.

- When the coupling mode is "DC": the DC and AC components of the signal under test can both pass the channel.
- When the coupling mode is "AC": the DC components of the signal under test are blocked.
- When the coupling mode is "GND": the DC and AC components of the signal under test are both blocked.

Press **CH1** → **Coupling** and use  to select the desired coupling mode (the default is DC). The current coupling mode is displayed in the channel status label at the bottom of the screen as shown in the figure below. You can also press **Coupling** continuously to switch the coupling mode.



DC



AC



GND

## Bandwidth Limit

MSO1000Z/DS1000Z supports the bandwidth limit function which can reduce the display noise. For example, the signal under test is a pulse with high frequency oscillation.

- When the bandwidth limit is disabled, the high frequency components of the signal under test can pass the channel.
- When limiting the bandwidth to 20 MHz, the high frequency components of the signal under test that exceed 20 MHz are attenuated.

Press **CH1**, then press **BW Limit** continuously to switch the bandwidth limit state (the default is OFF). When the bandwidth limit is enabled, the character "B" will be displayed in the channel status label at the bottom of the screen.



**Note:** Bandwidth limit can reduce the noise as well as attenuate or eliminate the high frequency components of the signal.

## Probe Ratio

MSO1000Z/DS1000Z allows user to set the probe attenuation ratio manually. Press **CH1** → **Probe** and use  to select the desired probe ratio. The probe ratio values available are as shown in the table below.

Table 2-1 Probe Ratio

Menu	Attenuation Ratio (display amplitude of the signal : actual amplitude of the signal)
0.01X	0.01:1
0.02X	0.02:1
0.05X	0.05:1
0.1X	0.1:1
0.2X	0.2:1
0.5X	0.5:1
1X	1:1
2X	2:1
5X	5:1
10X (the default value)	10:1
20X	20:1
50X	50:1
100X	100:1
200X	200:1
500X	500:1
1000X	1000:1

## Waveform Invert

Press **CH1** → **Invert** to turn on or off waveform invert. When waveform invert is turned off, the waveform display is normal; when waveform invert is turned on, the waveform voltage values are inverted (as shown in the figures below).



(a) "Invert" Off

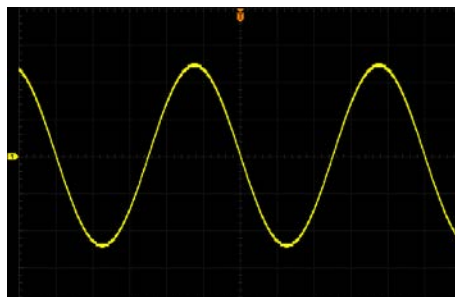

(b) "Invert" On

Figure 2-1 Waveform Invert

## Vertical Scale

Vertical scale refers to the voltage value per grid in the vertical direction on the screen and is usually expressed as V/div.

Press **CH1** and rotate **VERTICAL**  **SCALE** to adjust the vertical scale (clockwise to reduce the scale and counterclockwise to increase). The size of the displayed waveform will be changed accordingly. The scale information (as shown in the figure below) in the channel label at the bottom of the screen will change accordingly during the adjustment. The adjustable range of the vertical scale is related to the probe ratio currently set. By default, the probe ratio is 10X and the adjustable range of the vertical scale is from 10 mV/div to 100 V/div.



The vertical scale can be adjusted in "Coarse" or "Fine" mode. Press **CH1** → **Volts/Div** to switch the adjustment mode.

- Coarse adjustment (take counterclockwise as an example): set the vertical scale in 1-2-5 step namely 10 mV/div, 20 mV/div, 50 mV/div, 100 mV/div... 100 V/div.
- Fine adjustment: further adjust the vertical scale within a relatively smaller range to improve vertical resolution. If the amplitude of the input waveform is a little bit greater than the full scale under the current scale and the amplitude would be a little bit lower if the next scale is used, fine adjustment can be used to improve the amplitude of waveform display to view signal details.

**Note:** You can also press **VERTICAL**  **SCALE** to quickly switch between "Coarse"



and "Fine" adjustments.

When changing the vertical scale of the analog channel by rotating **VERTICAL SCALE**, you can select to expand or compress the waveform around the "Center" or "Ground". For more details, please refer to the introduction in "**Vertical Reference**".

## Amplitude Unit

Select the amplitude display unit for the current channel. The available units are W, A, V and U. When the unit is changed, the unit displayed in the channel label will change accordingly.

Press **CH1** → **Unit** to select the desired unit and the default is V.

## Channel Label

The instrument uses the number of the channel to mark the corresponding channel by default. For ease of use, you can also set a label for each channel, for example, "**CH1**". Press **CH1** → **Label** to enter the label setting menu. You can use the built-in label or manually input a label. Manual input does not support the Chinese input, and the length of the label cannot exceed 4 characters.

Press **Display** to turn on or off the channel label display. The default is CH1 when the channel label display is enabled.

Press **Template** to select the preset labels such as CH1, ACK, ADDR, BIT, CLK, CS, DATA, IN, MISO, MOSI, OUT, RX and TX, etc.

Press **Label Edit** and the label editing interface is automatically displayed as shown in the figure below. You can input the label manually.

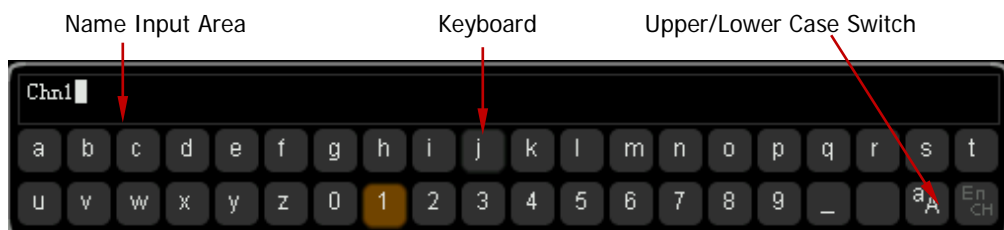







Figure 2-2 Label Editing Interface

For example, set the label to "**Chn1**". Press **Keyboard** to select the "Keyboard" area.

Select "A<sub>a</sub>" using  and press down  to switch it to "ªA". Select "C" using  and press down  to input the character. Use the same method to input "hn1". After finishing the input, press **OK** to finish the editing. If the **Display** is enabled, the label  will be displayed at the left of CH1 waveform.

To modify or delete the input character, press **Name** to select the "Name Input Area" and use  to select the character to be modified or deleted. Enter the desired character or press **Delete** to delete the character selected.

## Delay Calibration of the Analog Channel

When using an oscilloscope for actual measurement, the transmission delay of the probe cable may bring relatively greater error (zero offset). MSO1000Z/DS1000Z supports user to set a delay time to calibrate the zero offset of the corresponding channel. Zero offset is defined as the offset of the crossing point of the waveform and trigger level line relative to the trigger position, as shown in the figure below.

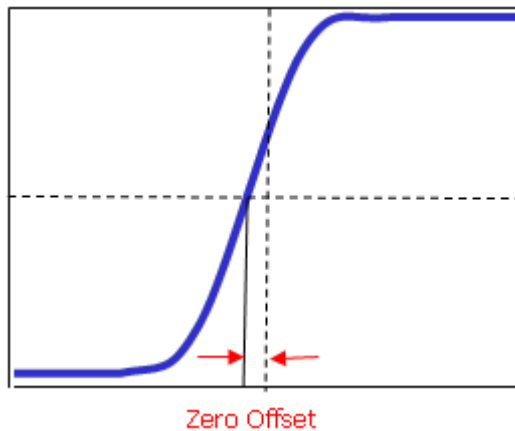



Figure 2-1 Zero Offset

Press **CH1** → **Delay-Cal** and use  to set the desired delay time. The range available is from -100 ns to 100 ns. Pressing down the multifunction knob  will reset the delay time to 0.00 s.

**Note:** This parameter is related to the instrument model and the current horizontal time base setting. The larger the horizontal time base is, the larger the setting step will be. Take MSO1104Z-S as an example. The step values under different horizontal time base are as shown in the table below.

Table 2-2 Relation between delay calibration time step and horizontal time base

Horizontal Time Base	Delay Calibration Time Step
5 ns	100 ps
10 ns	200 ps
20 ns	400 ps
50 ns	1 ns
100 ns	2 ns
200 ns	4 ns
500 ns	10 ns
1 $\mu$ s to 10 $\mu$ s	20 ns

**Note:** When the horizontal time base is equal to or greater than 10  $\mu$ s, the delay calibration time cannot be adjusted.



## **Chapter 3 To Set the Horizontal System**

The contents of this chapter:

- Delayed Sweep
- Time Base Mode

## Delayed Sweep

Delayed sweep can be used to enlarge a length of waveform horizontally to view waveform details.

Press **MENU** in the horizontal control area (HORIZONTAL) at the front panel and press **Delayed** to enable or disable delayed sweep.

**Note:** To enable delayed sweep, the current time base mode must be "YT".

In delayed sweep mode, the screen is divided into two display areas as shown in the figure below.

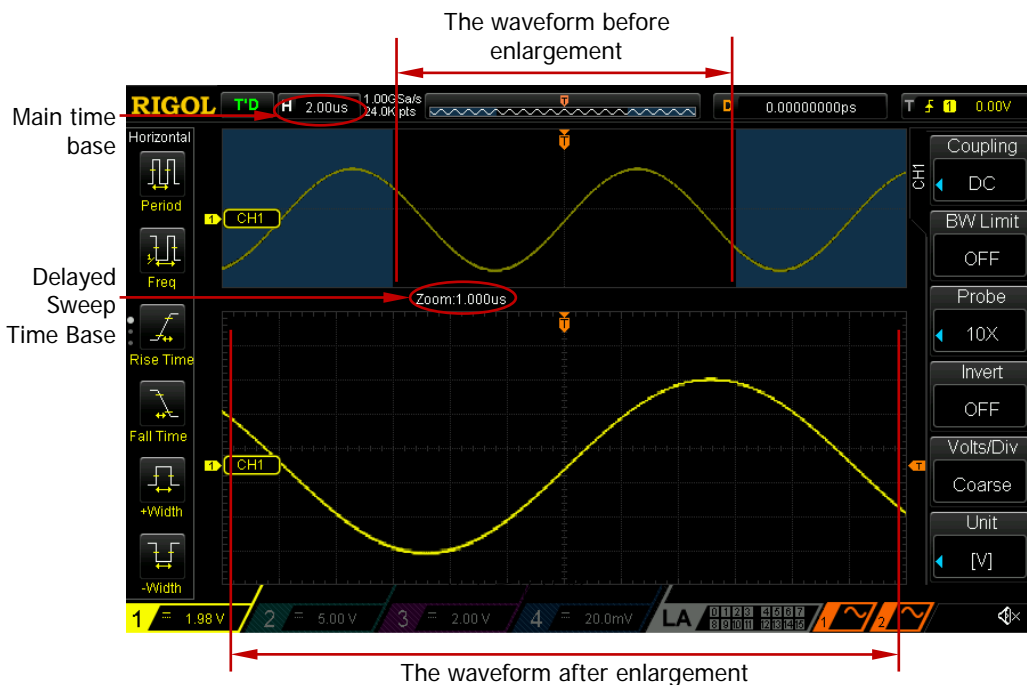

Figure 3-1 Delayed Sweep Mode

### The waveform before enlargement:

The waveform in the area that is not covered by subtransparent blue in the upper part of the screen is the waveform before enlargement. You can turn **HORIZONTAL POSITION** to move the area left and right or turn **HORIZONTAL SCALE** to enlarge or reduce this area.

### The waveform after enlargement:

The waveform in the lower part of the screen is the horizontally expanded waveform. Compared to the main time base, the delayed time base has increased the waveform resolution (as shown in the figure above).

**Note:** The delayed time base should be less than or equal to the main time base.

**Tip**

You can also press down **HORIZONTAL**  **SCALE** (delayed sweep shortcut key) to directly switch to the delayed sweep mode.

## Time Base Mode

Press **MENU** in the horizontal control area (HORIZONTAL) at the front panel and then press **Time Base** to select the time base mode of the oscilloscope. The default is YT.

## YT Mode

In this mode, the Y axis represents voltage and the X axis represents time.

**Note:** Only when this mode is enabled, can "Delayed Sweep" be turned on. In this mode, when the horizontal time base is greater than or equal to 200 ms, the instrument enters slow sweep mode. For the details, please refer to the introduction of slow sweep in "Roll Mode".

## XY Mode

In this mode, the oscilloscope changes the two channels from voltage-time display mode to voltage-voltage display mode. The phase deviation between two signals with the same frequency can be easily measured via Lissajous method. The figure below shows the measurement schematic diagram of the phase deviation.

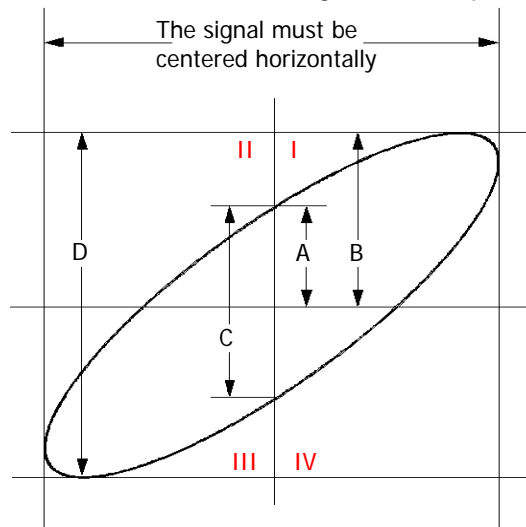

Figure 3-2 Measurement Schematic Diagram of Phase Deviation

According to  $\sin\theta = A/B$  or  $C/D$  (wherein,  $\theta$  is the phase deviation angle between the two channels and the definitions of A, B, C and D are as shown in the figure above), the phase deviation angle is obtained, that is:

$$\theta = \pm \arcsin(A/B) \text{ or } \pm \arcsin(C/D)$$

If the principal axis of the ellipse is within quadrant I and III, the phase deviation angle obtained should be within quadrant I and IV, namely within  $(0 \text{ to } \pi/2)$  or  $(3\pi/2 \text{ to } 2\pi)$ . If the principal axis of the ellipse is within quadrant II and IV, the phase deviation angle obtained should be within quadrant II and III, namely within  $(\pi/2 \text{ to } \pi)$  or  $(\pi \text{ to } 3\pi/2)$ .

The XY function can be used to measure the phase deviation occurred when the signal under test passes through a circuit network. Connect the oscilloscope to the circuit to monitor the input and output signals of the circuit.

**Application example:** measure the phase deviation of the input signals of two channels.

### Method 1: Use Lissajous method

1. Connect a sine signal to CH1 and then connect a sine signal with the same frequency and amplitude but a  $90^\circ$  phase deviation to CH2.
2. Press **AUTO** and then adjust the vertical positions of CH1 and CH2 to 0 V.
3. Set the time base mode to XY, press **X-Y** and select "CH1-CH2". Rotate **Horizontal SCALE** to adjust the sample rate properly to get better Lissajous figure for better observation and measurement.
4. Rotate **VERTICAL SCALE** of CH1 and CH2 to make the signals easy to observe. At this point, the circle as shown in the figure below should be displayed.

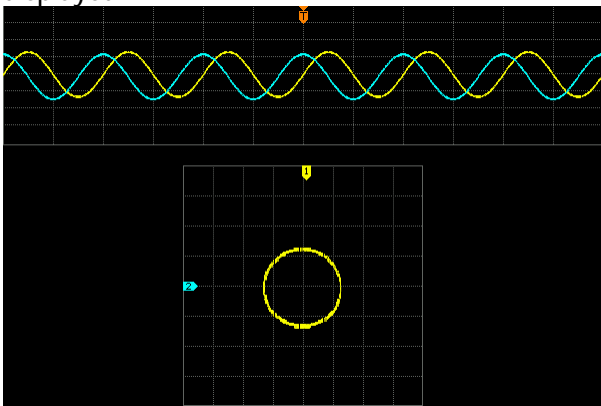

5. Observe the measurement result shown in the figure above. According to the measurement schematic diagram of the phase deviation (as shown in Figure 3-2),  $A/B$  ( $C/D$ ) = 1. Thus, the phase deviation angle  $\theta = \pm \arcsin 1 = 90^\circ$ .



**Note:**

- The maximum sample rate of XY mode is 500 MSa/s. Generally, longer sample waveform can ensure better display effect of Lissajous figure. But due to the limitation of the memory depth, you have to reduce the waveform sample rate to acquire longer waveform (refer to the introduction in "**Memory Depth**"). Therefore, during the measurement, reducing the sample rate properly can acquire better display effect of Lissajous figure.
- When XY mode is enabled, "**Delayed Sweep**" will be disabled automatically.
- Press **X-Y** to select "CH1-CH2, CH1-CH3, CH1-CH4, CH2-CH3, CH2-CH4, CH3-CH4". After you choose any of the options, the instrument automatically turns on the two corresponding channels and turns off the other two channels. The X-axis tracks the voltage of the first channel in each option; the Y-axis tracks the voltage of the second channel in each option.
- The following functions are not available in XY mode:  
"**Delayed Sweep**", "**Vectors**", "**Protocol Decoding**", "**Acquisition Mode**", "**Pass/Fail Test**", "**Waveform Record**", "**Digital Channel**" and "**To Set the Persistence Time**".

**Method 2: Use the shortcut measurement function**

Please refer to "Phase  $f1 \rightarrow 2$ " and "Phase  $\bar{1} \rightarrow 2$ " measurement functions of "Delay and Phase" on page **6-28**.

## Roll Mode

In this mode, the waveform scrolls from right to left to update the display. The horizontal position and trigger control of the waveform are not available. The range of horizontal scale adjustment is from 200 ms to 50.0 s.

**Note:** When Roll mode is enabled, the waveform "**horizontal position**", "**Delayed Sweep**", "**Protocol Decoding**", "**Pass/Fail Test**", "**Waveform Record**", "**To Set the Persistence Time**" and "**To Trigger the Oscilloscope**" are not available.

**Slow Sweep**

Slow sweep is similar to Roll mode. In YT mode, when the horizontal time base is set to 200 ms/div or slower, the instrument enters "slow sweep" mode in which the instrument first acquires the data at the left of the trigger point and then waits for a trigger event. After the trigger occurs, the instrument continues to finish the waveform at the right of the trigger point. When slow sweep mode is used to observe low frequency signal, DC "**Channel Coupling**" mode is recommended.



## Chapter 4 To Set the Sample System

The contents of this chapter:

- Acquisition Mode
- Sin(x)/x
- Sample Rate
- Memory Depth
- Antialiasing

## Acquisition Mode

The acquisition mode is used to control how to generate waveform points from sample points.

Press **Acquire** → **Mode** at the front panel and use  to select the desired acquisition mode (the default is normal), then press down the knob to select this mode. You can also press **Mode** continuously to switch the acquisition mode.

### Normal

In this mode, the oscilloscope samples the signal at equal time interval to rebuild the waveform. For most of the waveforms, the best display effect can be obtained using this mode.

### Peak Detect

In this mode, the oscilloscope acquires the maximum and minimum values of the signal within the sample interval to get the envelope of the signal or the narrow pulse of the signal that might be lost. In this mode, signal confusion can be prevented but the noise displayed would be larger.

In this mode, the oscilloscope can display all the pulses with pulse widths at least as wide as the sample period.

### Average

In this mode, the oscilloscope averages the waveforms from multiple samples to reduce the random noise of the input signal and improve the vertical resolution. Greater number of averages can lower the noise and increase the vertical resolution; while at the same time, it will slow the response of the displayed waveform to the waveform changes.

When "Average" mode is selected, press **Averages** and use  to set the desired number of averages. The number of averages can be set to 2, 4, 8, 16, 32, 64, 128, 256, 512 or 1024. The default is 2.

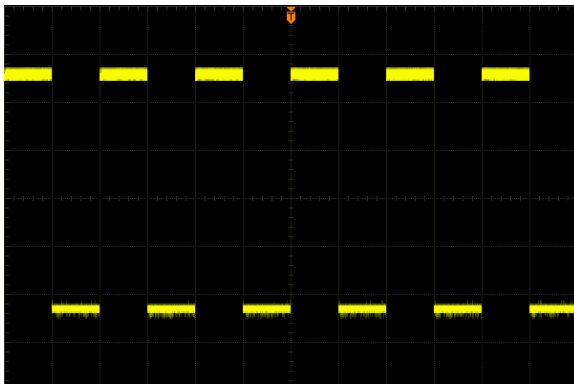

Figure 4-1 The Waveform before Average

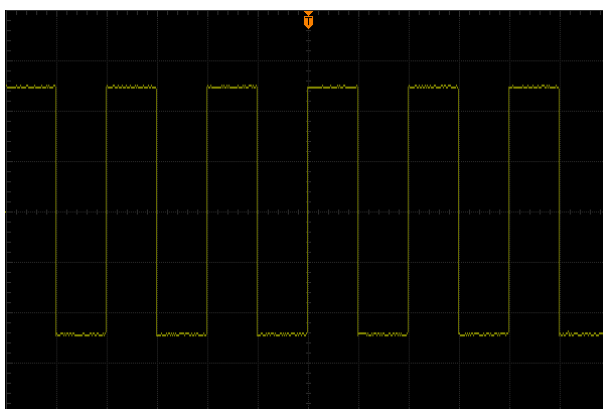

Figure 4-2 The Waveform after 256 Averages

## High Resolution

This mode uses a kind of ultra-sample technique to average the neighboring points of the sample waveform to reduce the random noise on the input signal and generate much smoother waveforms on the screen. This is generally used when the sample rate of the digital converter is higher than the storage rate of the acquisition memory.

**Note:** "Average" and "High Res" modes use different averaging methods. The former uses "Multi-sample Average" and the latter uses "Single Sample Average".

## Sin(x)/x

Press **Sin(x)/x** to enable or disable the dynamic sine interpolation function which can acquire better restoration of the original waveform.

**Note:** If the number of channels currently turned on is less than three, **Sin(x)/x** is grayed out and disabled.

## Sample Rate

The maximum sample rate of MSO1000Z/DS1000Z is 1 GSa/s.

**Note:** The sample rate is displayed in the status bar at the upper side of the screen and in the **Sa Rate** menu and can be changed by adjusting the horizontal time base through **HORIZONTAL**  **SCALE** or modifying the "Memory Depth".

The influence on the waveform when the sample rate is too low:

1. **Waveform Distortion:** when the sample rate is too low, some waveform details are lost and the waveform displayed is rather different from the actual signal.

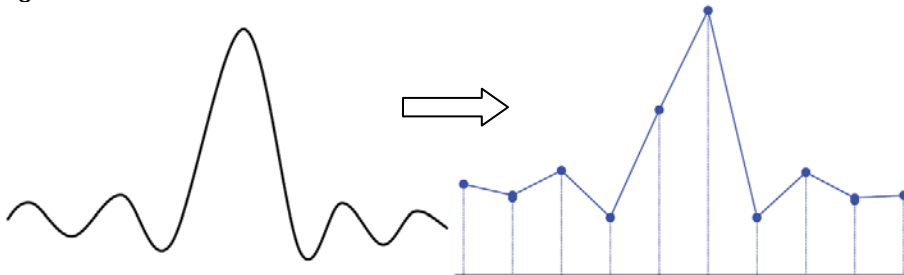

2. **Waveform Confusion:** when the sample rate is lower than twice the actual signal frequency (Nyquist Frequency), the frequency of the waveform rebuilt from the sample data is lower than the actual signal frequency.

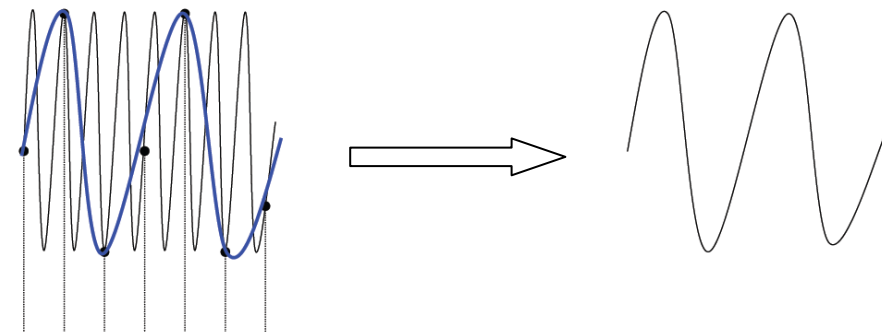

3. **Waveform Leakage:** when the sample rate is too low, the waveform rebuilt from the sample data does not reflect all the actual signal information.

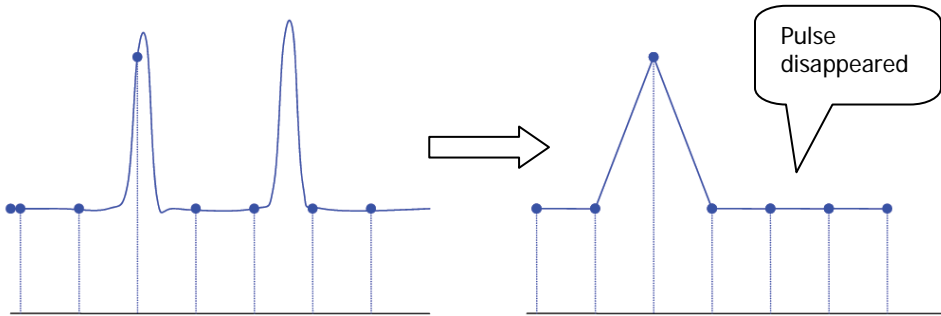

## Memory Depth

Memory depth refers to the number of waveform points that the oscilloscope can store in a single trigger sample and it reflects the storage ability of the sample memory. MSO1000Z/DS1000Z provides up to 24 Mpts memory depth (optional) and 12 Mpts standard memory depth.

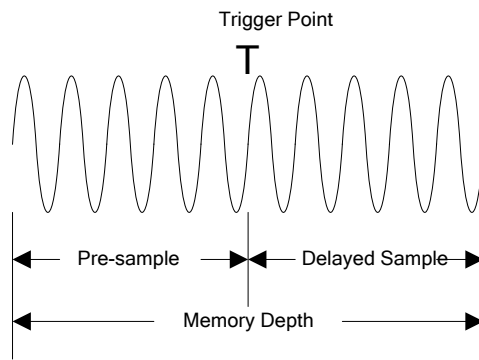

Figure 4-1 Memory Depth

The relation of memory depth, sample rate and horizontal time base scale fulfills the equation below:

$$MDepth = SRate \times TScale \times HDivs \quad (4-1)$$

*MDepth* : Memory depth. The unit is pts.

*SRate* : Sample rate. The unit is Sa/s.

*TScale* : Horizontal time base scale. The unit is s/div.

*HDivs* : Number of grids horizontally. The unit is div. For MSO1000Z/DS1000Z, this value is 12.

Therefore, under the same horizontal time base scale, higher memory depth can ensure higher sample rate.

Press **Acquire** → **Mem Depth**, use  to switch to the desired memory depth (the default is auto) and then press down the knob to select the option. You can also press **Mem Depth** continuously to switch the memory depth.

- For analog channels:
  - When a single channel is enabled, the memory depths available include Auto, 12kPoints, 120kPoints, 1.2MPoints, 12MPoints and 24MPoints (optional).
  - When dual channels are enabled, the memory depths available include Auto, 6kPoints, 60kPoints, 600kPoints, 6MPoints and 12MPoints (optional).
  - When three or four channels are enabled, the memory depths available include Auto, 3kPoints, 30kPoints, 300kPoints, 3MPoints and 6MPoints (optional).



- For digital channels:
  - When 8 channels are enabled, the memory depths available include Auto, 12kPoints, 120kPoints, 1.2MPoints, 12MPoints and 24MPoints (optional).
  - When 16 channels are enabled, the memory depths available include Auto, 6kPoints, 60kPoints, 600kPoints, 6MPoints and 12MPoints (optional).

**Note:** In "Auto" mode, the oscilloscope selects the memory depth automatically according to the current sample rate.

## Antialiasing

At slower sweep speed, the sample rate is reduced and a dedicated display algorithm can be used to minimize the possibility of aliasing.

Press **Acquire** → **Anti-aliasing** to enable or disable the antialiasing function. By default, antialiasing is disabled and waveform aliasing is more possible.



## Chapter 5 To Trigger the Oscilloscope

As for trigger, you set certain trigger condition according to the requirement and when a waveform in the waveform stream meets this condition, the oscilloscope captures this waveform as well as the neighbouring part and displays them on the screen. For digital oscilloscope, it samples waveform continuously no matter whether it is stably triggered, but only stable trigger can ensure stable display. The trigger module ensures that every time base sweep or acquisition starts from the user-defined trigger condition, namely every sweep is synchronous to the acquisition and the waveforms acquired overlap to display stable waveform.

Trigger setting should be based on the features of the input signal, thus you need to have some knowledge of the signal under test to quickly capture the desired waveform. This oscilloscope provides abundant advanced trigger functions which can help you to focus on the desired waveform details.

The contents of this chapter:

- Trigger Source
- Trigger Mode
- Trigger Coupling
- Trigger Holdoff
- Noise Rejection
- Trigger Type
- Trigger Output Connector

## Trigger Source

Press **MENU** → **Source** in the trigger control area (TRIGGER) at the front panel to select the desired trigger source. Analog channels CH1-CH4, digital channels D0-D15 or the AC Line can all be used as trigger source.

### Analog channel input:

Signals input from analog channels CH1-CH4 can all be used as trigger source. No matter whether the channel selected is enabled, the channel can work normally.

**Note:** When any channel among D7-D0 is enabled, CH4 cannot be used as trigger source; when any channel among D15-D8 is enabled, CH3 cannot be used as trigger source.

### Digital channel input:

Only the digital channels turned on can be used as trigger source. Please refer to the introduction of "**To Turn on/off the Digital Channel**" to turn on the desired digital channel.

### AC line:

The trigger signal is obtained from the AC power input of the oscilloscope. AC trigger is usually used to measure signals relevant to the AC power frequency. For example, stably trigger the waveform output from the transformer of a transformer substation; it is mainly used in related measurements of the power industry.

## Trigger Mode

The following is the schematic diagram of the acquisition memory. To easily understand the trigger event, the acquisition memory is divided into the pre-trigger buffer and post-trigger buffer.

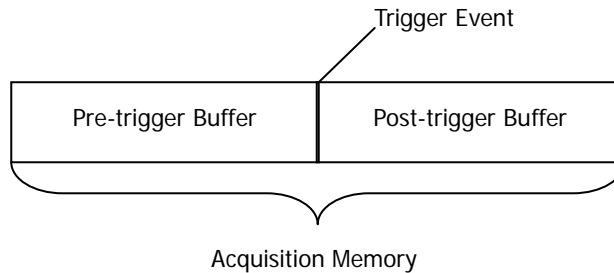

Figure 5-1 Schematic Diagram of the Acquisition Memory

After the system runs, the oscilloscope operates by first filling the pre-trigger buffer. It starts searching for a trigger after the pre-trigger buffer is filled. While searching for the trigger, the data sampled will still be transmitted to the pre-trigger buffer (the new data will continuously overwrite the previous data). When a trigger is found, the pre-trigger buffer contains the data acquired just before the trigger. Then, the oscilloscope will fill the post-trigger buffer and display the data in the acquisition memory. If the acquisition is activated via **RUN/STOP**, the oscilloscope will repeat this process; if the acquisition is activated via **SINGLE**, the oscilloscope will stop after finishing a single acquisition (you can pan and zoom the waveform currently displayed).

Press **MODE** in the trigger control area (TRIGGER) at the front panel or press **MENU** → **Sweep** to select the desired trigger mode. The corresponding status light of the mode currently selected turns on.

- Auto: in this trigger mode, the oscilloscope will force a trigger if the specified trigger condition is not found.
- Normal: in this trigger mode, the oscilloscope only triggers when the specified trigger condition is found.
- Single: in this trigger mode, the oscilloscope generates a trigger when the specified trigger condition is found and then stops.

**Note:** In "Normal" and "Single" trigger modes, pressing **FORCE** can generate a trigger signal forcibly.

## Trigger Coupling

Trigger coupling decides which kind of components will be transmitted to the trigger module. Please distinguish it from "**Channel Coupling**".

- DC: allow DC and AC components into the trigger path.
- AC: block all the DC components and attenuate signals lower than 75 Hz.
- LF Reject: block the DC components and reject the low frequency components (lower than 75 kHz).
- HF Reject: reject the high frequency components (higher than 75 kHz).

Press **MENU** → **Setting** → **Coupling** in the trigger control area (TRIGGER) at the front panel to select the desired coupling type (the default is DC).

**Note:** Trigger coupling is only valid in edge trigger.

## Trigger Holdoff

Trigger holdoff can be used to stably trigger complex waveforms (such as modulated waveform). Holdoff time is the amount of time that the oscilloscope waits for re-arming the trigger module after generating a correct trigger. The oscilloscope will not trigger even if the trigger condition is met during the holdoff time and will only re-arm the trigger module after the holdoff time expires.

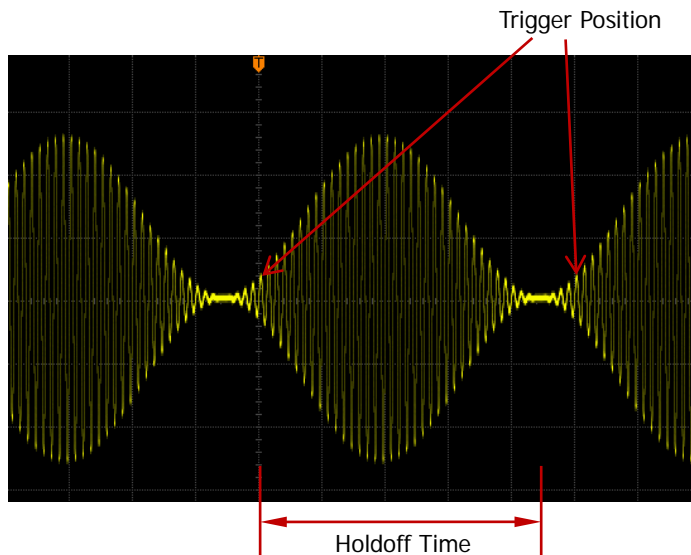



Figure 5-2 Schematic Diagram of Trigger Holdoff

Press **MENU** → **Setting** → **Holdoff** in the trigger control area (TRIGGER) at the front panel and use the multifunction knob  to modify the holdoff time (the default is 16 ns) until the waveform triggers stably. The adjustable range of holdoff time is from 16 ns to 10 s.

**Note:** Trigger holdoff is not available for video trigger, timeout trigger, setup/hold trigger, Nth edge trigger, RS232 trigger, I2C trigger and SPI trigger.

## Noise Rejection

Noise rejection can reject the high frequency noise in the signal and reduce the possibility of miss-trigger of the oscilloscope.

Press **MENU** → **Setting** → **NoiseReject** in the trigger control area (TRIGGER) at the front panel to enable or disable noise rejection.

**Note:** This function is not available when the current trigger source is a digital channel.

## Trigger Type

MSO1000Z/DS1000Z provides various trigger functions. Among various trigger types, RS232 trigger (optional), I2C trigger (optional) and SPI trigger (optional) are serial bus triggers.



- Edge Trigger
- Pulse Trigger
- Slope Trigger
- Video Trigger
- Pattern Trigger
- Duration Trigger
- TimeOut Trigger (Optional)
- Runt Trigger (Optional)
- Window Trigger (Optional)
- Delay Trigger (Optional)
- Setup/Hold Trigger (Optional)
- Nth Edge Trigger (Optional)
- RS232 Trigger (Optional)
- I2C Trigger (Optional)
- SPI Trigger (Optional)



## Edge Trigger

Trigger on the trigger threshold of the specified edge of the input signal.

### Trigger Type:

Press **Type**, rotate  to select "Edge" and press down . At this point, the trigger setting information is displayed at the upper right corner of the screen.

For example, . The trigger type is edge trigger; the trigger source is CH1; the trigger level is 0.00 V.



### Source Selection:

Press **Source** to open the signal source list and select CH1-CH4, AC or D0-D15. For the details, please refer to the introduction in "**Trigger Source**". The current trigger source is displayed at the upper right corner of the screen.

**Note:** Select channel with signal input as trigger source to obtain stable trigger.

### Edge Type:

Press **Slope** to select the kind of edge of the input signal on which the oscilloscope triggers. The current edge type is displayed at the upper right corner of the screen.

- : trigger on the rising edge of the input signal when the voltage level meets the preset trigger level.
- : trigger on the falling edge of the input signal when the voltage level meets the preset trigger level.
- : trigger on the rising or falling edge of the input signal when the voltage level meets the preset trigger level.



### Trigger Mode:

Press **Sweep** to open the trigger mode list and select auto, normal or single. For the details, please refer to "**Trigger Mode**". The corresponding status light of the current trigger mode turns on.

### Trigger Setting:

Press **Setting** to set the trigger parameters (trigger coupling, trigger holdoff and noise rejection) under this trigger type.



### Trigger Level:



When the trigger source is an analog channel, trigger occurs only when the signal reaches the preset trigger level. You can modify the level using **TRIGGER**  **LEVEL**. At this point, an orange trigger level line and the trigger mark "" appear on the screen and move up and down with the rotation of the knob. The trigger level value (such as ) at the lower left corner of the screen also changes accordingly. When stopping turning the knob, the trigger level line disappears in about 2 s.

## Pulse Trigger

Trigger on the positive or negative pulse with a specified width. In this mode, the oscilloscope will trigger when the pulse width of the input signal satisfies the specified pulse width condition.

### Trigger Type:

Press **Type**, rotate  to select "Pulse" and press down . At this point, the trigger setting information is displayed at the upper right corner of the screen.

For example,    168mV. The trigger type is pulse trigger; the trigger source is CH1; the trigger level is 168 mV.

### Source Selection:

Press **Source** to open the signal source list and select CH1-CH4 or D0-D15. For the details, please refer to the introduction in "**Trigger Source**". The current trigger source is displayed at the upper right corner of the screen.

**Note:** Select channel with signal input as trigger source to obtain stable trigger.

### Pulse Condition:

In this oscilloscope, positive pulse width is defined as the time difference between the two crossing points of the trigger level and positive pulse; negative pulse width is defined as the time difference between the two crossing points of the trigger level and negative pulse, as shown in the figure below.

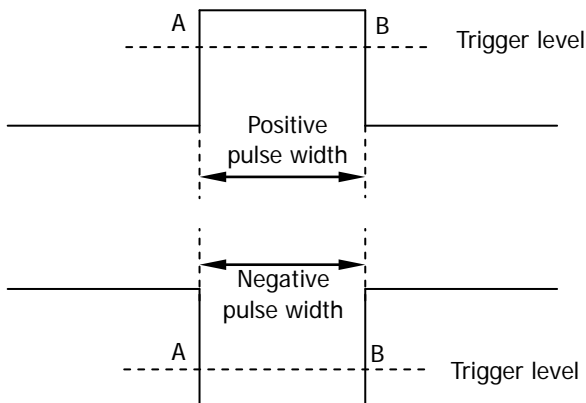















Figure 5-3 Positive Pulse Width/Negative Pulse Width

Press **When** to select the desired pulse width condition.

- : trigger when the positive pulse width of the input signal is greater than the specified pulse width.
- : trigger when the positive pulse width of the input signal is lower than the specified pulse width.
- : trigger when the positive pulse width of the input signal is greater than the specified lower limit of pulse width and lower than the specified upper limit

- of pulse width.
- : trigger when the negative pulse width of the input signal is greater than the specified pulse width.
  - : trigger when the negative pulse width of the input signal is lower than the specified pulse width.
  - : trigger when the negative pulse width of the input signal is greater than the specified lower limit of pulse width and lower than the specified upper limit of pulse width.

#### Pulse Width Setting:

- When the **Pulse Condition** is set to , ,  or , press **Setting** and use  to input the desired value. The range available is from 8 ns to 10 s.
- When the **Pulse Condition** is set to  or , press **Upper Limit** and **Lower Limit** and use  to input the desired values respectively. The range of the upper limit is from 16 ns to 10 s. The range of the lower limit is from 8 ns to 9.99 s.

**Note:** The lower limit of the pulse width must be lower than the upper limit.

#### Trigger Mode:

Press **Sweep** to open the trigger mode list and select auto, normal or single. For the details, please refer to "**Trigger Mode**". The corresponding status light of the current trigger mode turns on.

#### Trigger Setting:

Press **Setting** to set the trigger parameters (trigger holdoff and noise rejection) under this trigger type.



#### Trigger Level:





When the trigger source is an analog channel, you can use **TRIGGER**  **LEVEL** to modify the level. For the details, please refer to the introduction of "**Trigger Level**".

## Slope Trigger

In slope trigger, the oscilloscope triggers on the positive or negative slope of the specified time. This trigger mode is applicable to ramp and triangle waveforms.

### Trigger Type:

Press **Type**, rotate  to select "Slope" and press down . At this point, the trigger setting information is displayed at the upper right corner of the screen.

For example,    . The trigger type is slope trigger; the trigger source is CH1; the difference between the upper limit of trigger level and the lower limit of trigger level is 400 mV.

### Source Selection:

Press **Source** to switch the signal source and select CH1-CH4. For the details, please refer to the introduction in "**Trigger Source**". The current trigger source is displayed at the upper right corner of the screen.

**Note:** Select channel with signal input as trigger source to obtain stable trigger.

### Slope Condition:

In this oscilloscope, positive slope time is defined as the time difference between the two crossing points of trigger level line A and B with the rising edge; negative slope time is defined as the time difference between the two crossing points of trigger level line A and B with the falling edge as shown in the figure below.

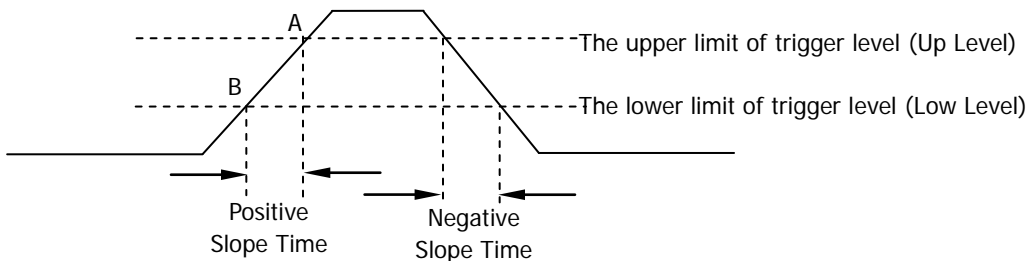















Figure 5-4 Positive Slope Time/Negative Slope Time

Press **When** to select the desired slope condition.

- : trigger when the positive slope time of the input signal is greater than the specified time.
- : trigger when the positive slope time of the input signal is lower than the specified time.
- : trigger when the positive slope time of the input signal is greater than the specified lower limit of time and lower than the specified upper limit of time.
- : trigger when the negative slope time of the input signal is greater than the specified time.
- : trigger when the negative slope time of the input signal is lower than the specified time.



- : trigger when the negative slope time of the input signal is greater than the specified lower limit of time and lower than the specified upper limit of time.



### Time Setting:





- When the **Slope Condition** is set to , ,  or , press **Time** and use  to input the desired value. The range available is from 8 ns to 10 s.
- When the **Slope Condition** is set to  or , press **Upper Limit** and **Lower Limit** and use  to input the desired values respectively. The range of time upper limit is from 16 ns to 10 s. The range of the time lower limit is from 8 ns to 9.99 s.

**Note:** The time lower limit must be lower than the upper limit.



### Vertical Window and Trigger Level:

After the trigger condition setting is completed, adjust the trigger level using **TRIGGER**  **LEVEL** to correctly trigger the signal and obtain stable waveform. The adjustment mode of the trigger level is different when different vertical window is selected in slope trigger. Press **Vertical** and use  to select the desired vertical window or press down **Vertical** continuously to switch the vertical window. You can choose to only adjust the upper limit, the lower limit or both of them.

- : only adjust the upper limit of the trigger level. During the adjustment, "UP Level" and "Slew Rate" change accordingly but "Low Level" remains unchanged.
- : only adjust the lower limit of the trigger level. During the adjustment, "Low Level" and "Slew Rate" change accordingly but "UP Level" remains unchanged.
- : adjust the upper and lower limits of the trigger level at the same time. During the adjustment, "UP Level" and "Low Level" change accordingly but "Slew Rate" remains unchanged.

When the **Slope Condition** is set to , ,  or , the current trigger level and slew rate will be displayed at the lower left corner of the screen, as shown in figure 5-5 (a). The formula of slew rate is:

$$SlewRate = \frac{UpLevel - LowLevel}{Time} \quad (5-1)$$

When the **Slope Condition** is set to  or , the current trigger level and slew rate range will be displayed at the lower left corner of the screen, as shown in figure 5-5 (b). The formula of slew rate range is:

$$SlewRate = \frac{UpLevel - LowLevel}{UpperLimit} \sim \frac{UpLevel - LowLevel}{LowerLimit} \quad (5-2)$$



Figure 5-5 Trigger Level Information Display

**Note:** Under the "Slope" trigger menu, you can also press down the trigger level knob continuously to switch the vertical window.

During the adjustment of trigger level, two orange trigger level lines and two trigger marks (T1 and T2) appear on the screen and move up and down with the rotation of the knob. At the same time, the current trigger level information is displayed at the lower right corner of the screen according to different slope condition settings. After stopping turning the knob, the trigger level lines and trigger level information disappear in about 2 s.

**Trigger Mode:**

Press **Sweep** to open the trigger mode list and select auto, normal or single. For the details, please refer to "**Trigger Mode**". The corresponding status light of the current trigger mode turns on.



**Trigger Setting:**

Press **Setting** to set the trigger parameters (trigger holdoff and noise rejection) under this trigger type.

## Video Trigger

The video signal can include image information and timing information and can adopt different standards and formats. MSO1000Z/DS1000Z can trigger on the standard video signal field or line of NTSC (National Television Standards Committee), PAL (Phase Alternating Line) or SECAM (Sequential Couleur A Memoire).

### Trigger Type:

Press **Type**, rotate  to select "Video" and press down . At this point, the trigger setting information is displayed at the upper right corner of the screen.



For example, . The trigger type is video trigger; the trigger source is CH1; the trigger level is 0.00 V.

### Source Selection:

Press **Source** to switch the signal source and select CH1-CH4. For the details, please refer to the introduction in "**Trigger Source**". The current trigger source is displayed at the upper right corner of the screen.

**Note:** Select channel with signal input as trigger source to obtain stable trigger.

### Video Polarity:

Press **Polarity** to select the desired video polarity. The polarities available are positive polarity () and negative polarity (.

### Sync:

Press **Sync** to select the desired sync type.

- All Line: trigger on the first line found.
- Line: for NTSC and PAL/SECAM video standards, trigger on the specified line in the odd or even field.

**Note:** When this sync trigger mode is selected, you can modify the line number using  in **Line** menu with a step of 1.

The range of the line number is from 1 to 525 (NTSC), 1 to 625 (PAL/SECAM), 1 to 525 (480P) or 1 to 625 (576P).

- Odd: trigger on the rising edge of the first ramp pulse in the odd field.
- Even: trigger on the rising edge of the first ramp pulse in the even field.

### Video Standard:

Press **Standard** to select the desired video standard.

- NTSC: the field frequency is 60 fields per second and the frame frequency is 30 frames per second. The TV scan line is 525 with the even field goes first and the odd field follows behind.
- PAL/SECAM:
  - PAL: the frame frequency is 25 frames per second. The TV scan line is 625 with the odd field goes first and the even field follows behind.
  - SECAM: the frame frequency is 25 frames per second. The TV scan line is 625 with interlaced scan.

- 480P: the frame frequency is 60 frames per second; the TV scan line is 525; progressive scan; the line frequency is 31.5 kHz.
- 576P: the frame frequency is 60 frames per second; the TV scan line is 625; progressive scan.

**Trigger Mode:**

Press **Sweep** to open the trigger mode list and select auto, normal or single. For the details, please refer to "**Trigger Mode**". The corresponding status light of the current trigger mode turns on.

**Trigger Setting:**

Press **Setting** to set the trigger parameter (noise rejection) under this trigger type.

**Trigger Level:**

Use **TRIGGER**  **LEVEL** to modify the level. For the details, please refer to the introduction of "**Trigger Level**".

**Tips**

- For a better observation of the waveform details in the video signal, you can set a larger memory depth first.
- In the trigger debugging process of video signals, the frequency in different part of the signal can be reflected by different brightness as **RIGOL** digital oscilloscope provides the intensity graded color display function. Experienced users can quickly judge the signal quality and discover abnormalities.



## Pattern Trigger

Identify a trigger condition by looking for a specified pattern. This pattern is a logical "AND" combination of channels. Each channel can have a value of high (H), low (L) or don't care (X). A rising or falling edge (you can only specify a single edge) can be specified for one channel included in the pattern. When an edge is specified, the oscilloscope will trigger at the edge specified if the pattern set for the other channels are true (namely the actual pattern of the channel is the same with the preset pattern). If no edge is specified, the oscilloscope will trigger on the last edge that makes the pattern true. If all the channels in the pattern are set to "Don't Care", the oscilloscope will not trigger.

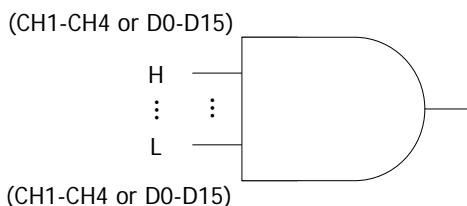





Figure 5-6 Pattern Trigger

### Trigger Type:

Press **Type**, rotate  to select "Pattern" and press down . At this point, the trigger setting information is displayed at the upper right corner of the screen.

For example, . The trigger type is pattern trigger; the current trigger source is CH1; the trigger level is 0.00 V.

### Source Selection:

Press **Source** to open the signal source list and select CH1-CH4 or D0-D15. For the details, please refer to the introduction in "**Trigger Source**". The current trigger source is displayed at the upper right corner of the screen.

### Pattern Setting:

Press **Code** to set the pattern of the current signal source. At this point, the corresponding pattern is displayed at the bottom of the screen. The patterns of channels CH1-CH4 and D0-D15 are presented from left to right as shown in the figure below.



- **H**: set the pattern of the channel selected to "H", namely the voltage level is higher than the trigger level of the channel.
- **L**: set the pattern of the channel selected to "L", namely the voltage level is lower than the trigger level of the channel.
- **X**: set the pattern of the channel selected to "Don't Care", namely this channel is not used as a part of the pattern. When all channels in the pattern are set to

"Don't Care", the oscilloscope will not trigger.

-  or : set the pattern to the rising or falling edge of the channel selected.

#### Note:

- When digital channels D7-D0 are enabled, CH4 is automatically disabled; the corresponding pattern cannot be set and is replaced by X. When D15-D8 are enabled, CH3 is automatically disabled; the corresponding pattern cannot be set and is replaced by X.
- Only one edge (rising or falling edge) can be specified in the pattern. If one edge item is currently defined and then another edge item is defined in another channel in the pattern, the former edge item defined will be replaced by X.

#### All Bits:

Press **AllBits** to set the patterns of all trigger sources to the pattern settings selected currently.

#### Trigger Mode:

Press **Sweep** to open the trigger mode list and select auto, normal or single. For the details, please refer to "**Trigger Mode**". The corresponding status light of the current trigger mode turns on.

#### Trigger Setting:

Press **Setting** to set the trigger parameters (trigger holdoff and noise rejection) under this trigger type.

#### Trigger Level:

For the analog channels, the trigger level of each channel needs to be set independently. For example, set the trigger level of CH1. Press **Source** to select CH1, and then use **TRIGGER**  **LEVEL** to modify the level. For the details, please refer to the introduction of "**Trigger Level**".

## Duration Trigger

In duration trigger, the instrument identifies a trigger condition by looking for the duration of a specified pattern. This pattern is a logical "AND" combination of the channels. Each channel can have a value of high (H), low (L) or don't care (X). The instrument triggers when the duration ( $\Delta T$ ) of this pattern meets the preset time, as shown in the figure below.

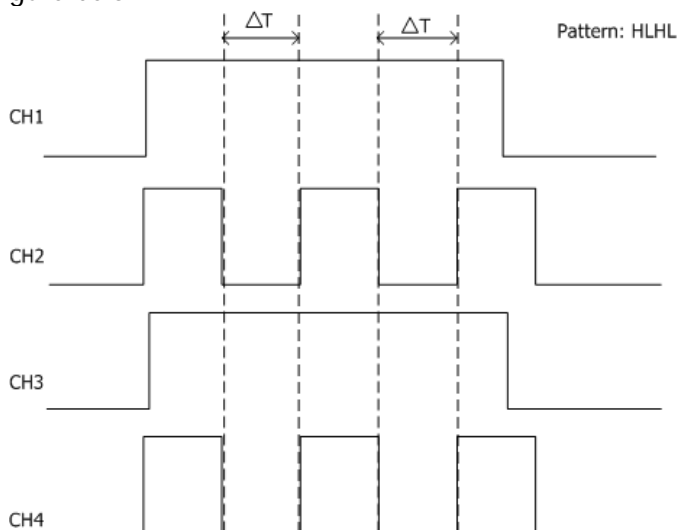





Figure 5-7 Duration Trigger

### Trigger Type:

Press **Type**, rotate  to select "Duration" and press down . At this point, the trigger setting information is displayed at the upper right corner of the screen.

For example, . The trigger type is duration trigger; the current trigger source is CH1; the trigger level is 0.00 V.



### Source Selection:

Press **Source** to open the signal source list and select CH1-CH4 or D0-D15. For the details, please refer to the introduction in "**Trigger Source**". The current trigger source is displayed at the upper right corner of the screen.

### Pattern Setting:

Press **Code** to set the pattern of the current channel. At this point, the pattern setting area (as shown in the figure below) is displayed at the bottom of the screen.



- : set the pattern of the channel selected to "H", namely the voltage level is higher than the trigger level of the channel.
- : set the pattern of the channel selected to "L", namely the voltage level is

lower than the trigger level of the channel.

- **X**: set the pattern of the channel selected to "Don't Care", namely this channel is not used as a part of the pattern. When all channels in the pattern are set to "Don't Care", the oscilloscope will not trigger.

**Note:** When digital channels D7-D0 are enabled, CH4 is automatically disabled; its corresponding pattern cannot be set and is replaced by X. When D15-D8 are enabled, CH3 is automatically disabled; its corresponding pattern cannot be set and is replaced by X.

#### All Bits:

Press **AllBits** to set the patterns of all trigger sources to the pattern settings selected currently.

#### Trigger Condition:

Press **When** to select the desired trigger condition.

- **>**: trigger when the duration of the pattern is greater than the preset time. Press **Time** to set the duration of the pattern and the range is from 8 ns to 10 s.
- **<**: trigger when the duration of the pattern is lower than the preset time. Press **Time** to set the duration of the pattern and the range is from 8 ns to 10 s.
- **<>**: trigger when the duration of the pattern is lower than the upper limit of the preset time and greater than the lower limit of the preset time. Press **Upper Limit** to set the upper limit of the duration of the pattern and the range is from 16 ns to 10 s. Press **Lower Limit** to set the lower limit of the duration of the pattern and the range is from 8 ns to 9.99 s.

**Note:** The time lower limit must be lower than the time upper limit.

#### Trigger Mode:

Press **Sweep** to open the trigger mode list and select auto, normal or single. For the details, please refer to "**Trigger Mode**". The corresponding status light of the current trigger mode turns on.

#### Trigger Setting:

Press **Setting** to set the trigger parameters (trigger holdoff and noise rejection) under this trigger type.

#### Trigger Level:

Press **Source** to select CH1 to CH4 respectively; use **TRIGGER**  **LEVEL** to modify the trigger level for each channel. For the details, please refer to the introduction of "**Trigger Level**".

## TimeOut Trigger (Optional)

In timeout trigger, the instrument triggers when the time interval ( $\Delta T$ ) from when the rising edge (or falling edge) of the input signal passes through the trigger level to when the neighbouring falling edge (or rising edge) passes through the trigger level is greater than the timeout time set, as shown in the figure below.

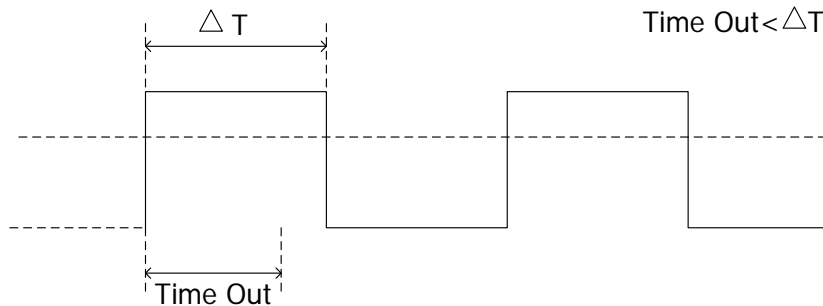





Figure 5-8 TimeOut Trigger

### Trigger Type:

Press **Type**, rotate  to select "TimeOut" and press down . At this point, the trigger setting information is displayed at the upper right corner of the screen.

For example, . The trigger type is timeout trigger; the trigger source is CH1; the trigger level is 0.00 V.



### Source Selection:

Press **Source** to open the signal source list and select CH1-CH4 or D0-D15. For the details, please refer to the introduction in "**Trigger Source**". The current trigger source is displayed at the upper right corner of the screen.

**Note:** Select channel with signal input as trigger source to obtain stable trigger.

### Edge Type:

Press **Slope** to select the type of the first edge of the input signal that passes through the trigger level.

- : start timing when the rising edge of the input signal passes through the trigger level.
- : start timing when the falling edge of the input signal passes through the trigger level.
- : start timing when any edge of the input signal passes through the trigger level.

### Timeout Time:

Timeout time represents the minimum time that the clock signal must be in the idle state before the oscilloscope starts searching for the data meets the trigger condition. Press **TimeOut** to set the timeout time of timeout trigger and the range is from 16

ns to 10 s.

**Trigger Mode:**

Press **Sweep** to open the trigger mode list and select auto, normal or single. For the details, please refer to "**Trigger Mode**". The corresponding status light of the current trigger mode turns on.

**Trigger Setting:**

Press **Setting** to set the trigger parameter (noise rejection) under this trigger type.

**Trigger Level:**

When the trigger source is an analog channel, you can use **TRIGGER  LEVEL** to modify the level. For the details, please refer to the introduction of "**Trigger Level**".

## Runt Trigger (Optional)

This trigger mode is used to trigger pulses that pass through one trigger level but fail to pass through the other trigger level as shown in the figure below.

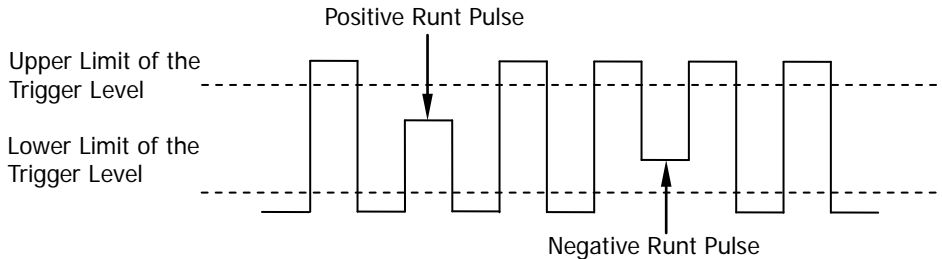





Figure 5-9 Runt Trigger

### Trigger Type:

Press **Type**, rotate  to select "Runt" and press down . At this point, the trigger setting information is displayed at the upper right corner of the screen.

For example, . The trigger type is runt trigger; the trigger source is CH1; the difference between the upper limit of trigger level and the lower limit of trigger level is 10.00 V.



### Source Selection:

Press **Source** to switch the signal source and select CH1-CH4. For the details, please refer to the introduction in "**Trigger Source**". The current trigger source is displayed at the upper right corner of the screen.

**Note:** Select channel with signal input as trigger source to obtain stable trigger.

### Pulse Polarity:

Press **Polarity** to select the pulse polarity of runt trigger.

- : positive polarity. The instrument triggers on the positive runt pulse.
- : negative polarity. The instrument triggers on the negative runt pulse.

### Qualifier:

Press **Qualifier** to set the trigger conditions of runt trigger.

- **None**: do not set the trigger condition of runt trigger.
- **>**: trigger when the runt pulse width is greater than the lower limit of pulse width. Press **Lower Limit** to set the minimum pulse width of runt trigger. The range available is from 8.00 ns to 10 s.
- **<**: trigger when the runt pulse width is lower than the upper limit of pulse width. Press **Upper Limit** to set the maximum pulse width of runt trigger. The range available is from 16.0 ns to 10.0 s.
- **<>**: trigger when the runt pulse width is greater than the lower limit and lower than the upper limit of pulse width. Press **Upper Limit** to set the maximum pulse width of runt trigger and the range is from 16.0 ns to 10.0 s; press **Lower**



**Limit** to set the minimum pulse width of runt trigger and the range is from 8.00 ns to 9.99 s.

**Note:** The lower limit of the pulse width must be lower than the upper limit.

### Vertical Window and Trigger Level:

After the trigger condition setting is completed, you need to adjust the trigger level to correctly trigger the signal and obtain stable waveform. The adjustment mode of the trigger level is different when different vertical window is selected in the runt trigger. Press **Window** and use  to select the desired vertical window or press down **Window** continuously to switch the vertical window. You can choose to only adjust the upper limit, the lower limit or both of them. For more details, please refer to the following introduction.

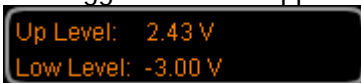

**Note:** Under the "Runt" trigger menu, you can also press down **TRIGGER**  **LEVEL** continuously to switch the vertical window.

After the vertical window type is selected, you can use **Trigger**  **LEVEL** to adjust the trigger level. During the adjustment, two orange trigger level lines and trigger marks ( and ) appear on the screen and move up and down with the rotation of the knob. At the same time, the current trigger level values are displayed at the lower left corner of the screen (as shown in the figure below). The trigger level lines and trigger marks disappear after you stop rotating the knob for about 2 s.



Up Level: 2.43 V  
Low Level: -3.00 V

The adjustment mode of the trigger level differs when different vertical window is selected.

- : only adjust the upper limit of the trigger level. During the adjustment, the "Up Level" changes accordingly and "Low Level" remains unchanged.
- : only adjust the lower limit of the trigger level. During the adjustment, the "Low Level" changes accordingly and the "Up Level" remains unchanged.
- : adjust the upper and lower limits of the trigger level at the same time. During the adjustment, the "Up Level" and "Low Level" change accordingly.

### Trigger Mode:

Press **Sweep** to open the trigger mode list and select auto, normal or single. For the details, please refer to "**Trigger Mode**". The corresponding status light of the current trigger mode turns on.

### Trigger Setting:



Press **Setting** to set the trigger parameters (trigger holdoff and noise rejection) under this trigger type.



## Window Trigger (Optional)

Window trigger provides a high trigger level and a low trigger level. The instrument triggers when the input signal passes through the high trigger level or the low trigger level.

### Trigger Type:

Press **Type**, rotate  to select "Window" and press down . At this point, the trigger setting information is displayed at the upper right corner of the screen.

For example, . The trigger type is window trigger; the trigger source is CH1; the difference between the upper limit of trigger level and the lower limit of trigger level is 2.00 V.



### Source Selection:

Press **Source** to switch the trigger source and select CH1-CH4. For the details, please refer to the introduction in "**Trigger Source**". The current trigger source is displayed at the upper right corner of the screen.

**Note:** Select channel with signal input as trigger source to obtain stable trigger.

### Window Type:

Press **WndType** to select the kind of edge of the input signal on which the oscilloscope triggers.

- : trigger on the rising edge of the input signal when the voltage level is greater than the preset high trigger level.
- : trigger on the falling edge of the input signal when the voltage level is lower than the preset low trigger level.
- : trigger on any edge of the input signal when the voltage level meets the preset trigger level.

### Trigger Position:

After selecting the window type, press **Position** to further specify the time point of trigger by selecting the trigger position.

- **Enter**: trigger when the trigger signal enters the specified trigger level range.
- **Exit**: trigger when the input signal exits the specified trigger level range.
- **Time**: trigger when the accumulated hold time after the trigger signal enters the specified trigger level range is equal to the window time. When this type is selected, press **Time** to set the window time. The range is from 8 ns to 10 s. For the setting method, please refer to the introduction in "**Parameter Setting Method**".

### Vertical Window and Trigger Level:

Press **Window** to select the desired vertical window type and use **Trigger ** **LEVEL** to adjust the trigger level. For detailed operation, please refer to the introduction in "**Vertical Window and Trigger Level**" in runt trigger.

**Trigger Mode:**

Press **Sweep** to open the trigger mode list and select auto, normal or single. For the details, please refer to "**Trigger Mode**". The corresponding status light of the current trigger mode turns on.

**Trigger Setting:**

Press **Setting** to set the trigger parameters (trigger holdoff and noise rejection) under this trigger type.

## Delay Trigger (Optional)

In delay trigger, you need to set signal source A and signal source B. The oscilloscope triggers when the time difference ( $\Delta T$ ) between the specified edges of source A (Edge A) and source B (Edge B) meets the preset time limit, as shown in the figure below.

**Note:** Edge A and Edge B must be neighbouring edges.

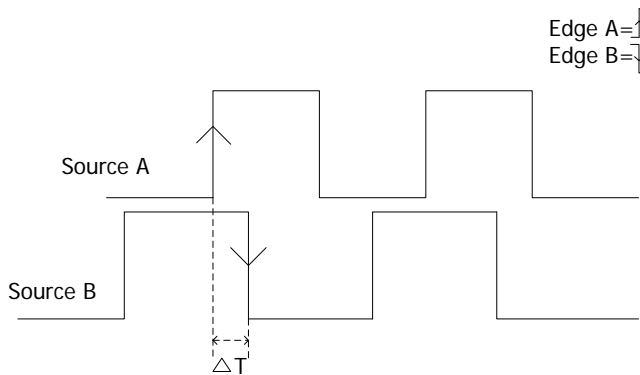





Figure 5-10 Delay Trigger

### Trigger Type:

Press **Type** to open the trigger type list. Rotate  to select "Delay" and press down . At this point, the trigger setting information is displayed at the upper right corner of the screen.

For example, . The trigger type is delay trigger; the current trigger source is CH1; the trigger level is 0.00 V.

### Source A:

Press **SourceA** to select CH1-CH4 as the trigger source of signal source A. For the details, please refer to the introduction in "**Trigger Source**". The current trigger source is displayed at the upper right corner of the screen.

**Note:** Select channel with signal input as trigger source to obtain stable trigger.

### Edge A:

Press **EdgeA** to select the trigger edge type of signal source A in delay trigger. It can be set to the rising edge or falling edge.

### Source B:

Press **SourceB** to select CH1-CH4 as the trigger source of signal source B. For the details, please refer to the introduction in "**Trigger Source**". The current trigger source is displayed at the upper right corner of the screen.

**Note:** Select channel with signal input as trigger source to obtain stable trigger.

**Edge B:**

Press **EdgeB** to select the trigger edge type of signal source B in delay trigger. It can be set to the rising edge or falling edge.

**Delay Type:**

Press **DelayType** to set the time limit condition of delay trigger.

- **>**: trigger when the time difference ( $\Delta T$ ) between the specified edges of source A and source B is greater than the preset time lower limit. Press **Lower Limit** to set the delay time lower limit in delay trigger and the range is from 8.00 ns to 10 s. For the setting method, please refer to the introduction in "**Parameter Setting Method**".
- **<**: trigger when the time difference ( $\Delta T$ ) between the specified edges of source A and source B is lower than the preset time upper limit. Press **Upper Limit** to set the delay time upper limit in delay trigger and the range is from 16.0 ns to 10.0 s. For the setting method, please refer to the introduction in "**Parameter Setting Method**".
- **<>**: trigger when the time difference ( $\Delta T$ ) between the specified edges of source A and source B is greater than the lower limit of the preset time and lower than the upper limit of the preset time. Press **Upper Limit** to set the upper limit of the delay time in delay trigger and the range is from 16.0 ns to 10.0 s. Press **Lower Limit** to set the lower limit of the delay time in delay trigger and the range is from 8.00 ns to 9.99 s. For the setting method, please refer to the introduction in "**Parameter Setting Method**".  
**Note:** The time lower limit must be lower than the time upper limit.
- **><**: trigger when the time difference ( $\Delta T$ ) between the specified edges of source A and source B is lower than the lower limit of the preset time or greater than the upper limit of the preset time. Press **Upper Limit** to set the upper limit of the delay time in delay trigger and the range is from 16.0 ns to 10.0 s. Press **Lower Limit** to set the lower limit of the delay time in delay trigger and the range is from 8.00 ns to 9.99 s. For the setting method, please refer to the introduction in "**Parameter Setting Method**".  
**Note:** The time lower limit must be lower than the time upper limit.

**Trigger Mode:**

Press **Sweep** to open the trigger mode list and select auto, normal or single. For the details, please refer to "**Trigger Mode**". The corresponding status light of the current trigger mode turns on.

**Trigger Setting:**

Press **Setting** to set the trigger parameters (trigger holdoff and noise rejection) under this trigger type.

**Trigger Level:**

The trigger level of each source needs to be set independently. For example, set the trigger level of source A. Press **SourceA** to select the desired source, and then use

**TRIGGER**  **LEVEL** to modify the level. For the details, please refer to the introduction of "**Trigger Level**".

## Setup/Hold Trigger (Optional)

In setup/hold trigger, you need to set the data signal line and clock signal line. The setup time starts when the data signal passes the trigger level and ends at the coming of the specified clock edge; the hold time starts at the coming of the specified clock edge and ends when the data signal passes the trigger level again (as shown in the figure below). The oscilloscope triggers when the setup time or hold time is lower than the preset time.

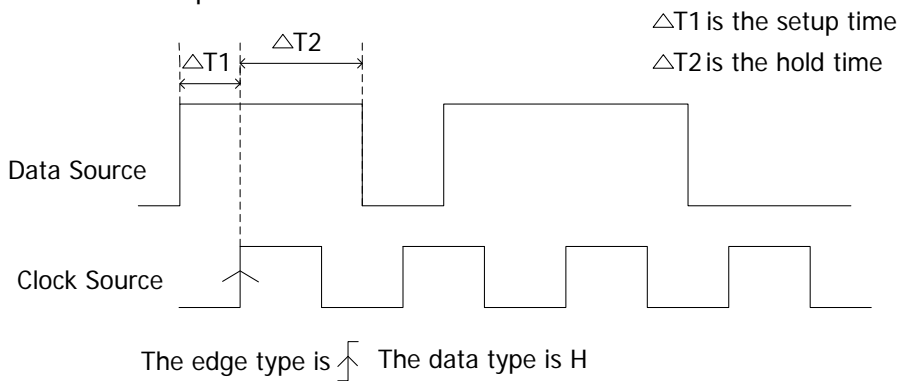

Figure 5-11 Setup/Hold Trigger

### Trigger Type:

Press **Type** to open the trigger type list. Rotate  $\curvearrowright$  to select "StpHold" and press down  $\curvearrowright$ . At this point, the trigger setting information is displayed at the upper right corner of the screen.

For example, **T**  $\star$  **CH1** **0.00V**. The trigger type is setup/hold trigger; the current trigger source is CH1; the trigger level is 0.00 V.

### Source Selection:

Press **DataSource** and **ClkSource** to set the signal sources of the data line and clock line respectively. They can be set to CH1-CH4. For the details, please refer to the introduction in "**Trigger Source**". The current trigger source is displayed at the upper right corner of the screen.

**Note:** Select channel with signal input as trigger source to obtain stable trigger.

### Edge Type:

Press **Slope** to select the desired clock edge type and it can be set to the rising edge or falling edge.

### Data Type:

Press **DataType** to set the effective pattern of the data signal to H (high level) or L (low level).

**Setup Type:**

It is used to select the different trigger types of setup/hold trigger. Press **SetupType** to select the desired setup type.

- **Setup**: the oscilloscope triggers when the setup time is less than the specified setup time. After selecting this type, press **Setup** to set the setup time and the range is from 8 ns to 1 s.
- **Hold**: the oscilloscope triggers when the hold time is less than the specified hold time. After selecting this type, press **Hold** to set the hold time and the range is from 8 ns to 1 s.
- **StpHold**: the oscilloscope triggers when the setup time and hold time are less than the specified times. After selecting this type, press **Setup** and **Hold** to set the setup time and hold time respectively and the range is from 8 ns to 1 s.



**Trigger Mode:**

Press **Sweep** to open the trigger mode list and select auto, normal or single. For the details, please refer to "**Trigger Mode**". The corresponding status light of the current trigger mode turns on.

**Trigger Setting:**

Press **Setting** to set the trigger parameter (noise rejection) under this trigger type.

**Trigger Level:**

Press **DataSource** and use **TRIGGER**  **LEVEL** to modify the trigger level of the data source channel. Press **ClkSource** and use **TRIGGER**  **LEVEL** to modify the trigger level of the clock source channel. For the details, please refer to the introduction of "**Trigger Level**".

## Nth Edge Trigger (Optional)

Trigger on the nth edge that appears after the specified idle time. For example, in the waveform shown in the figure below, the instrument should trigger on the second rising edge after the specified idle time (the time between two neighbouring rising edges) and the idle time should be set to  $P < \text{Idle Time} < M$ . Wherein, M is the time between the first rising edge and its previous rising edge and P is the maximum time between the rising edges participate in the counting.

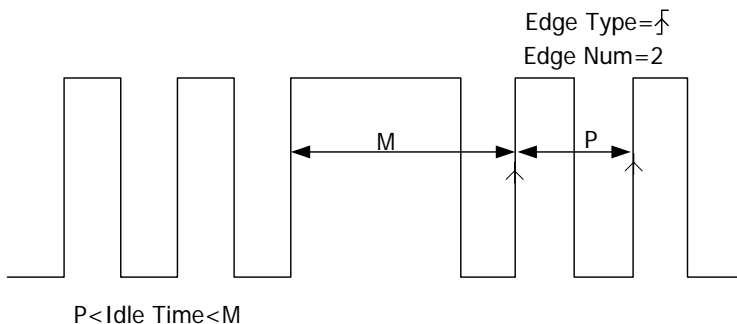

Figure 5-12 Nth Edge Trigger

### Trigger Type:

Press **Type** to open the trigger type list. Rotate to select "Nth" and press down . At this point, the trigger setting information is displayed at the upper right corner of the screen.

For example, . The trigger type is Nth edge trigger; the trigger source is CH1; the trigger level is 0.00 V.

### Source Selection:

Press **Source** to open the signal source list and select CH1-CH4 or D0-D15. For the details, please refer to the introduction in "**Trigger Source**". The current trigger source is displayed at the upper right corner of the screen.

**Note:** Select channel with signal input as trigger source to obtain stable trigger.

### Edge Type:

Press **Slope** to select the kind of edge of the input signal on which the oscilloscope triggers.

- : trigger on the rising edge of the input signal when the voltage level meets the specified trigger level.
- : trigger on the falling edge of the input signal when the voltage level meets the specified trigger level.



**Idle Time:**

Press **Idle** to set the idle time before the edge counting in Nth edge trigger. The range available is from 16 ns to 10 s.

**Edge Number:**

Press **Edge** to set the value of "N" in Nth edge trigger and the range available is from 1 to 65535.

**Trigger Mode:**

Press **Sweep** to open the trigger mode list and select auto, normal or single. For the details, please refer to "**Trigger Mode**". The corresponding status light of the current trigger mode turns on.

**Trigger Setting:**

Press **Setting** to set the trigger parameter (noise rejection) under this trigger type.

**Trigger Level:**

When the trigger source is an analog channel, you can use **TRIGGER  LEVEL** to modify the level. For the details, please refer to the introduction of "**Trigger Level**".

## RS232 Trigger (Optional)

RS232 bus is a serial communication mode used in the data transmission between PCs or between PC and terminal. In RS232 serial protocol, a character is transmitted as a frame of data which consists of 1 bit start bit, 5~8 bits data bits, 1 bit check bit and 1~2 bits stop bit(s). Its format is as shown in the figure below.

MSO1000Z/DS1000Z oscilloscope triggers when the start frame, error frame, check error or the specified data of the RS232 signal is detected.

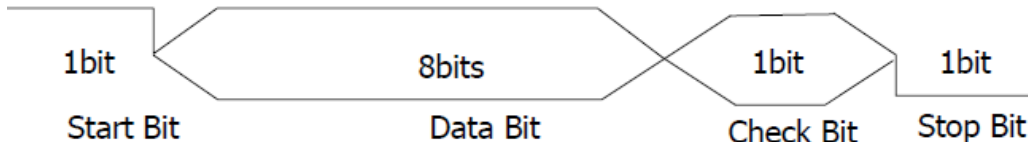





Figure 5-13 Schematic Diagram of RS232 Protocol

### Trigger Type:

Press **Type** to open the trigger type list. Rotate  to select "RS232" and press down . At this point, the trigger setting information is displayed at the upper right corner of the screen.



For example, . The trigger type is RS232 trigger; the current trigger source is CH1; the trigger level is 0.00 V.

### Source Selection:

Press **Source** to open the signal source list and select CH1-CH4 or D0-D15. For the details, please refer to the introduction in "**Trigger Source**". The current trigger source is displayed at the upper right corner of the screen.

**Note:** Select channel with signal input as trigger source to obtain stable trigger.

### Polarity

Press **Polarity** to select the polarity of data transmission. It can be set to "" or "" and the default is .

### Trigger Condition:

Press **When** to select the desired trigger condition.

- Start: trigger on the start frame position.
- Error: trigger when error frame is detected. After this trigger condition is selected:
  - press **Stop Bit** to select "1 bit" or "2 bits";
  - press **EvenOdd** to select "None", "Odd" or "Even".
 The oscilloscope will determine error frame according to the preset parameters.
- ChkError: trigger when check error is detected. When this trigger condition is selected, press **EvenOdd** to select "Odd" or "Even". The oscilloscope will determine check error according to the preset parameters.
- Data: trigger on the last bit of the preset data bits. When this trigger condition is

selected:

--press **Data Bits** to select "5 bits", "6 bits", "7 bits" or "8 bits";

--press **Data** and use  to set the data value of RS232 trigger. According to the setting in **Data Bits** and the ranges can be from 0 to 31, from 0 to 63, from 0 to 127 or from 0 to 255 respectively.

### **Baud Rate:**

Set the baud rate of data transmission (equal to specifying a clock frequency). Press **BaudRate** to set the desired baud rate to 2400 bps, 4800 bps, 9600 bps (default), 19200 bps, 38400 bps, 57600 bps, 115200 bps, 230400 bps, 460800 bps, 921600 bps, 1 Mbps and user-defined. When "User" is selected, press **Setup** to set a more specific value from 110 bps to 20000000 bps with an adjustment step of 1 bps. For the setting method, please refer to the introduction in "**Parameter Setting Method**".

### **Trigger Mode:**

Press **Sweep** to open the trigger mode list and select auto, normal or single. For the details, please refer to "**Trigger Mode**". The corresponding status light of the current trigger mode turns on.

### **Trigger Setting:**

Press **Setting** to set the trigger parameter (noise rejection) under this trigger type.

### **Trigger Level:**

When the trigger source is an analog channel, you can use **TRIGGER  LEVEL** to modify the level. For the details, please refer to the introduction of "**Trigger Level**".

## I2C Trigger (Optional)

I2C is a 2-wire serial bus used to connect the microcontroller and its peripheral device and is a bus standard widely used in the microelectronic communication control field.

The I2C serial bus consists of SCL and SDA. Its transmission rate is determined by SCL and its transmission data is determined by SDA, as shown in the figure below. MSO1000Z/DS1000Z triggers on the start condition, restart, stop, missing acknowledgement, specific device address or data value. Besides, it can also trigger on the specific device address and data values at the same time.

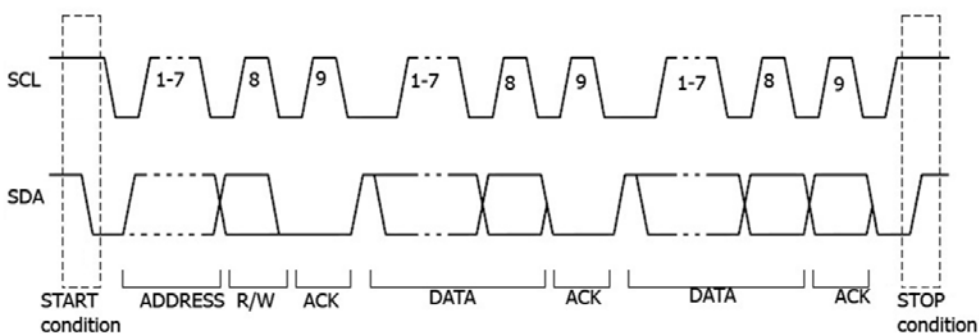





Figure 5-14 Schematic Diagram of I2C Protocol

### Trigger Type:

Press **Type** to open the trigger type list. Rotate  to select "I2C" and press down . At this point, the trigger setting information is displayed at the upper right corner of the screen.

For example, . The trigger type is I2C trigger; the current trigger source is CH1; the trigger level is 0.00 V.

### Source Selection:

Press **SCL** and **SDA** to specify the signal sources of SCL and SDA respectively. They can be set to CH1-CH4 or D0-D15. For the details, please refer to the introduction in "Trigger Source". The current trigger source is displayed at the upper right corner of the screen.

**Note:** Select channel with signal input as trigger source to obtain stable trigger.

### Trigger Condition:

Press **When** to select the desired trigger condition.

- Start: trigger when SDA data transitions from high level to low level while SCL is high level.
- Restart: trigger when another start condition occurs before a stop condition.
- Stop: trigger when SDA data transitions from low level to high level while SCL is high level.

- MissedACK: trigger when the SDA data is high level during any acknowledgement of SCL clock position.
- Address: the trigger searches for the specified address value. When this event occurs, the oscilloscope will trigger on the read/write bit. After this trigger condition is selected:
  - press **AddrBits** to select "7 bits", "8 bits" or "10 bits";
  - press **Address** to set the address value of I2C trigger. According to the setting in **AddrBits**, the range can be from 0 to 0x7F, from 0 to 0xFF or from 0 to 0x3FF;
  - press **Direction** to select "Read", "Write" or "R/W". **Note:** This setting is not available when **AddrBits** is set to "8 bits".
- Data: the trigger searches for the specified data value on the data line (SDA). When this event occurs, the oscilloscope will trigger on the clock line (SCL) transition edge of the last bit of data. After this trigger condition is selected:
  - press **Bit X** to select the desired data bit and the range is from 0 to (Byte Length×8-1);
  - press **Data** to set the data pattern of the current data bit to X, H or L;
  - press **Bytes** to set the length of the data and the range is from 1 to 5;
  - press **AllBits** to set the data pattern of all the data bits to the data pattern specified in **Data**.
- A&D: the oscilloscope searches for the specified address and data at the same time and triggers when the specified address and data are found. After this trigger condition is selected:
  - press **AddrBits** to select "7 bits", "8 bits" or "10 bits";
  - press **Address** and use  to set the address value. According to the setting in **AddrBits**, the range can be from 0 to 0x7F, from 0 to 0xFF or from 0 to 0x3FF;
  - press **Bit X** to select the desired data bit and the range is from 0 to (Byte Length×8-1);
  - press **Data** to set the data pattern of the current data bit to X, H or L;
  - press **Bytes** to set the length of the data and the range is from 1 to 5;
  - press **AllBits** to set the data pattern of all the data bits to the data pattern specified in **Data**;
  - press **Direction** to select "Read", "Write" or "R/W".

**Note:** This setting is not available when **AddrBits** is set to "8 bits".



### Trigger Mode:

Press **Sweep** to open the trigger mode list and select auto, normal or single. For the details, please refer to "**Trigger Mode**". The corresponding status light of the current trigger mode turns on.

**Trigger Setting:**

Press **Setting** to set the trigger parameter (noise rejection) under this trigger type.

**Trigger Level:**

When SCL is an analog channel, press **SCL** and use **TRIGGER**  **LEVEL** to modify the trigger level of the SCL channel. When SDA is an analog channel, press **SDA** and use **TRIGGER**  **LEVEL** to modify the trigger level of the SDA channel. For the details, please refer to the introduction of "**Trigger Level**".

## SPI Trigger (Optional)

In SPI trigger, after the CS or timeout condition is satisfied, the oscilloscope triggers when the specified data is found. When using SPI trigger, you need to specify the SCL clock sources and SDA data sources. Below is the sequential chart of SPI bus.

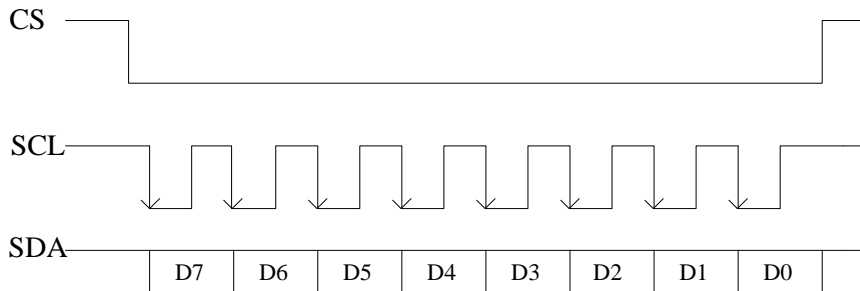





Figure 5-15 Sequential Chart of SPI Bus

### Trigger Type:

Press **Type** to open the trigger type list. Rotate  to select "SPI" and press down . At this point, the trigger setting information is displayed at the upper right corner of the screen.

For example, . The trigger type is SPI trigger; the current trigger source is CH1; the trigger level is 0.00 V.

### Source Selection:

Press **SCL** and **SDA** to specify the data sources of SCL and SDA respectively. They can be set to CH1-CH4 or D0-D15. For the details, please refer to the introduction in "Trigger Source". The current trigger source is displayed at the upper right corner of the screen.

**Note:** Select channel with signal input as trigger source to obtain stable trigger.

### Data Line Setting:

Press **Data** to set the data bits and data of SPI trigger.



- Press **DataBits** to set the number of bits of the serial data character string. It can be set to any integer between 4 and 32.
- Press **CurrentBit** to set the number of the data bit and the range is from 0 to (value specified in **DataBits** - 1).
- Press **Data** to set the value of the current bit to H, L or X.
- Press **AllBits** to set all the data bits to the value specified in **Data**.

### Trigger Condition:

Press **When** to select the desired trigger condition.



- **CS:** if the CS signal is valid, the oscilloscope will trigger when the data (SDA) satisfying the trigger conditions is found.
  - After selecting this condition, you can press **CS** to select the chip selection

signal line. The available channels are CH1-CH4 or D0-D15 (only the channels currently enabled can be selected). For the details, please refer to the introduction in "**Trigger Source**". The current trigger source is displayed at the upper right corner of the screen.

- After selecting this condition, you can press **Mode** to set the CS mode to "" (high level is valid) or "" (low level is valid).
- **Timeout**: the clock (SCL) signal need to maintain a certain idle time before the oscilloscope searches for a trigger. The oscilloscope will trigger on when the data (SDA) satisfying the trigger conditions is found. After selecting this condition, you can press **Timeout** to set the minimum idle time and the range is from 100 ns to 1 s.

#### Clock Edge:

Press **ClockEdge** to select the desired clock edge.

- : sample the SDA data on the rising edge of the clock.
- : sample the SDA data on the falling edge of the clock.



#### Trigger Mode:

Press **Sweep** to open the trigger mode list and select auto, normal or single. For the details, please refer to "**Trigger Mode**". The corresponding status light of the current trigger mode turns on.

#### Trigger Setting:

Press **Setting** to set the trigger parameter (noise rejection) under this trigger type.

#### Trigger Level:

When SCL is an analog channel, press **SCL** and use **TRIGGER**  **LEVEL** to modify the trigger level of the SCL channel. When SDA is an analog channel, press **SDA** and use **TRIGGER**  **LEVEL** to modify the trigger level of the SDA channel. For the details, please refer to the introduction of "**Trigger Level**".



## Trigger Output Connector

The trigger output connector (**[Trigger Out]**) at the rear panel can output trigger signals determined by the current setting.

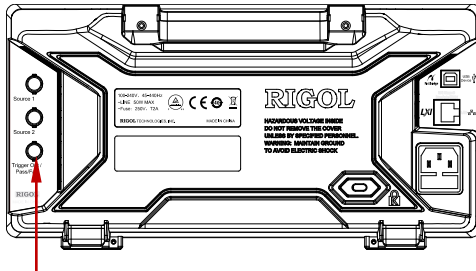

Trigger Output Connector

A signal which reflects the current oscilloscope capture rate can be output from **[Trigger Out]** connector each time a trigger is generated by the oscilloscope. If this signal is connected to a waveform display device to measure the frequency, the measurement result is equal to the current capture rate.

**Note:** If you press **Utility** → **Aux Out** to select "Pass/Fail" or press **Utility** → **Pass/Fail** → **Aux Out** to select "ON", in the pass/fail test, when a failure is detected, the oscilloscope outputs a negative pulse from the **[Trigger Out]** connector; when no failure is detected, the oscilloscope outputs a low level continuously from this connector.



## Chapter 6 MATH and Measurement

MSO1000Z/DS1000Z can make math operation, cursor measurement and auto measurement after data is sampled and displayed.

The contents of this chapter:

- Math Operation
- Auto Measurement
- Cursor Measurement

## Math Operation

MSO1000Z/DS1000Z can realize various math operations, including:

- Algebra operations:  $A+B$ ,  $A-B$ ,  $A \times B$  and  $A/B$
- Spectrum operation: FFT
- Logic operations:  $A \& B$ ,  $A || B$ ,  $A \wedge B$  and  $!A$
- Function operations: Intg, Diff, Sqrt, Lg, Ln, Exp and Abs
- Filter: Low Pass, High Pass, Band Pass, Band Stop
- Fx operations: combination of two operations. For the details, please refer to the introduction in "**Fx Operation**".





The results of math operation also allow further measurement.

Press **MATH** → **Math** → **Operator** in the vertical control area (VERTICAL) at the front panel to select the desired operation function. Press **Operation** to enable the operation. The result of math operation is displayed on the waveform marked with "M" on the screen.

## Addition

Add the waveform voltage values of signal source A and B point by point and display the results.

Press **MATH** → **Math** → **Operator** to select "A+B":

- Press **Operation** to enable or disable the addition operation function.
- Press **SourceA** and **SourceB** to select the desired channels (CH1, CH2, CH3, CH4 or fx (please refer to the introduction in "**Fx Operation**")).
- Press **Offset** and use  to adjust the vertical position of the operation results.
- Press **Scale** and use  to adjust the vertical scale of the operation results.
- Press **Scale Reset** to adjust the vertical scale of the operation results to the optimal value according to the current configuration.
- Press **Options** to set the start and end points of the operation results, enable or disable waveform invert, etc.
  - Press **Start** and use  to set the start point of the operation results.
  - Press **End** and use  to set the end point of the operation results.
  - Press **Invert** to enable or disable the inverted display function of the waveform.
  - Press **Auto Scale** to enable or disable the auto scale function. When auto scale is enabled, the instrument will adjust the vertical scale of the operation results to the optimal value according to the current configuration.
  - Press **fx Operator**, **fx A** and **fx B** to set the operator and signal sources of the inner layer operation of Fx operation (please refer to the introduction in

"Fx Operation").





**Note:** **Sens.** and **Smooth** are grayed out and disabled. **Sens.** is only available when a digital channel is selected as the source. **Smooth** is only available for differential operation.

- You can also use **HORIZONTAL**  **POSITION** and **HORIZONTAL**  **SCALE** to adjust the horizontal position and scale of the operation results.

## Subtraction

Subtract the waveform voltage values of signal source B from that of source A point by point and display the results.

Press **MATH** → **Math** → **Operator** to select "A-B":

- Press **Operation** to enable or disable the subtraction operation function.
- Press **SourceA** and **SourceB** to select the desired channels (CH1, CH2, CH3, CH4 or fx (please refer to the introduction in "Fx Operation")).
- Press **Offset** and use  to adjust the vertical position of the operation results.
- Press **Scale** and use  to adjust the vertical scale of the operation results.
- Press **Scale Reset** to adjust the vertical scale of the operation results to the optimal value according to the current configuration.
- Press **Options** to set the start and end points of the operation results, enable or disable waveform invert, etc.
  - Press **Start** and use  to set the start point of the operation results.
  - Press **End** and use  to set the end point of the operation results.
  - Press **Invert** to enable or disable the inverted display function of the waveform.
  - Press **Auto Scale** to enable or disable the auto scale function. When auto scale is enabled, the instrument will adjust the vertical scale of the operation results to the optimal value according to the current configuration.
  - Press **fx Operator**, **fx A** and **fx B** to set the operator and signal sources of the inner layer operation of Fx operation (please refer to the introduction in "Fx Operation").







**Note:** **Sens.** and **Smooth** are grayed out and disabled. **Sens.** is only available when a digital channel is selected as the source. **Smooth** is only available for differential operation.

- You can also use **HORIZONTAL**  **POSITION** and **HORIZONTAL**  **SCALE** to adjust the horizontal position and scale of the operation results.

## Multiplication

Multiply the waveform voltage values of signal source A and B point by point and display the results.

Press **MATH** → **Math** → **Operator** to select "A×B":

- Press **Operation** to enable or disable the multiplication operation function.
  - Press **SourceA** and **SourceB** to select the desired channels (CH1, CH2, CH3, CH4 or fx (please refer to the introduction in "Fx Operation")).
  - Press **Offset** and use  to adjust the vertical position of the operation results.
  - Press **Scale** and use  to adjust the vertical scale of the operation results.
  - Press **Scale Reset** to adjust the vertical scale of the operation results to the optimal value according to the current configuration.
  - Press **Options** to set the start and end points of the operation results, enable or disable waveform invert, etc.
    - Press **Start** and use  to set the start point of the operation results.
    - Press **End** and use  to set the end point of the operation results.
    - Press **Invert** to enable or disable the inverted display function of the waveform.
    - Press **Auto Scale** to enable or disable the auto scale function. When auto scale is enabled, the instrument will adjust the vertical scale of the operation results to the optimal value according to the current configuration.
    - Press **fx Operator**, **fx A** and **fx B** to set the operator and signal sources of the inner layer operation of Fx operation (please refer to the introduction in "Fx Operation").
- Note:** **Sens.** and **Smooth** are grayed out and disabled. **Sens.** is only available when a digital channel is selected as the source. **Smooth** is only available for differential operation.
- You can also use **HORIZONTAL**  **POSITION** and **HORIZONTAL**  **SCALE** to adjust the horizontal position and scale of the operation results.







## Division

Divide the waveform voltage values of signal source A by that of source B point by point and display the results. It can be used to analyze the multiple relationships of waveforms of two channels.

**Note:** When the voltage of signal source B is 0V, the division result is invalid and "NAN" is displayed at the bottom of the screen.

Press **MATH** → **Math** → **Operator** to select "A/B":

- Press **Operation** to enable or disable the division operation function.

- Press **SourceA** and **SourceB** to select the desired channels (CH1, CH2, CH3, CH4 or fx (please refer to the introduction in "**Fx Operation**")).
  - Press **Offset** and use  to adjust the vertical position of the operation results.
  - Press **Scale** and use  to adjust the vertical scale of the operation results.
  - Press **Scale Reset** to adjust the vertical scale of the operation results to the optimal value according to the current configuration.
  - Press **Options** to set the start and end points of the operation results, enable or disable waveform invert, etc.
    - Press **Start** and use  to set the start point of the operation results.
    - Press **End** and use  to set the end point of the operation results.
    - Press **Invert** to enable or disable the inverted display function of the waveform.
    - Press **Auto Scale** to enable or disable the auto scale function. When auto scale is enabled, the instrument will adjust the vertical scale of the operation results to the optimal value according to the current configuration.
    - Press **fx Operator**, **fx A** and **fx B** to set the operator and signal sources of the inner layer operation of Fx operation (please refer to the introduction in "**Fx Operation**").
- Note:** **Sens.** and **Smooth** are grayed out and disabled. **Sens.** is only available when a digital channel is selected as the source. **Smooth** is only available for differential operation.
- You can also use **HORIZONTAL**  **POSITION** and **HORIZONTAL**  **SCALE** to adjust the horizontal position and scale of the operation results.

# FFT

FFT (Fast Fourier Transform) is used to transform time domain signals to frequency domain components (frequency spectrum). MSO1000Z/DS1000Z oscilloscope provides FFT operation function which enables users to observe the time domain waveform and spectrum of the signal at the same time. FFT operation can facilitate the following works:

- Measure harmonic components and distortion in the system
- Display the characteristics of the noise in DC power
- Analyze vibration

Press **MATH** → **Math** → **Operator** to select "FFT". You can set the parameters of FFT operation.

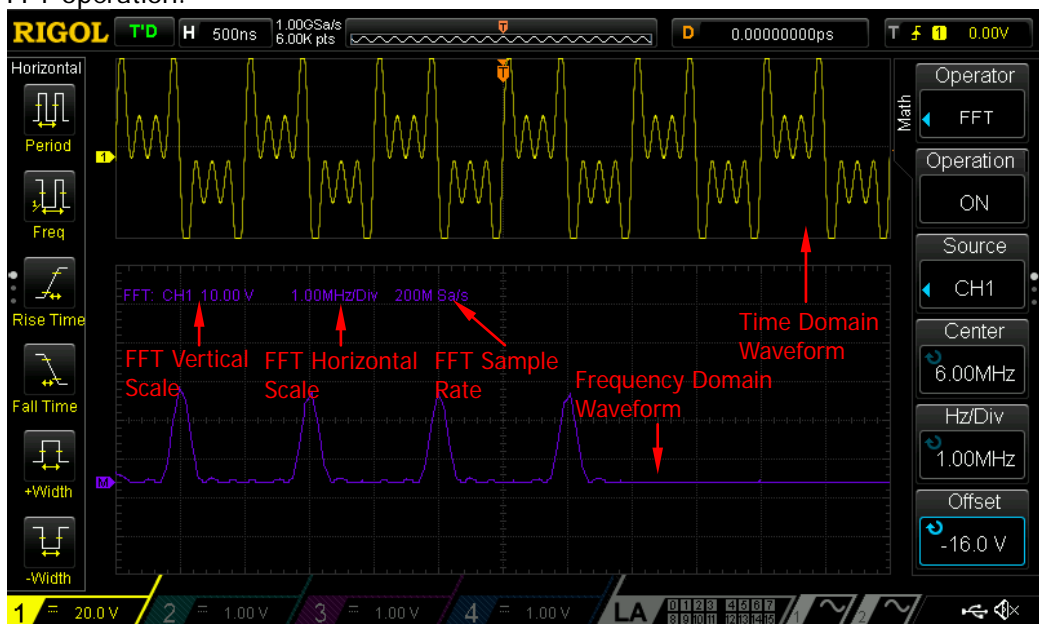

Figure 6-1 FFT Operation

## 1. Operation

Press **Operation** to enable or disable the FFT operation function. When FFT operation is enabled, the time domain waveform and frequency domain waveform are displayed separately on the screen by default as shown in Figure 6-1. The FFT sample rate is equal to 100 divided by the current horizontal time base in figure above.

## 2. Source Selection

Press **Source** to select the desired channel (CH1, CH2, CH3 or CH4).

## 3. Center Frequency

Press **Center** and use  to adjust the frequency of the frequency domain



waveform corresponding to the horizontal center of the screen.

**4. Horizontal Scale**

Press **Hz/Div** and use  to adjust the horizontal scale of the frequency domain waveform.

**5. Vertical Position**

Press **Offset** and use  to adjust the vertical position of the operation results.

**6. Vertical Scale**

Press **Scale** and use  to adjust the vertical scale of the operation results.

**7. Select Window Function**

Spectral leakage can be considerably decreased when a window function is used. MSO1000Z/DS1000Z provides six kinds of FFT window functions (as shown in the table on the next page) which have different characteristics and are applicable to measure different waveforms. You need to select the window function according to the waveform to be measured and its characteristics. Press **Window** to select the desired window function and the default is "Rectangle".

Table 6-1 Window Function

Window	Characteristics	Waveforms Suitable for Measurement
Rectangle	The best frequency resolution; the poorest amplitude resolution; similar to the situation when no window is multiplied.	Transient or short pulse, the signal levels before and after the multiplication are basically the same; Sine waveforms with the same amplitude and rather similar frequencies; Wide band random noise with waveform spectrum changing relatively slower.
Blackman	The best amplitude resolution; the poorest frequency resolution	Single frequency signal, search for higher order harmonics.
Hanning	Better frequency resolution and poorer amplitude resolution compared to Rectangle window.	Sine, periodic and narrow band random noise.
Hamming	A little bit better frequency resolution than Hanning	Transient or short pulse, the signal levels before and after the multiplication are rather different.
Flattop	Accurate measurement of signal.	Signal without accurate reference and require to accurately measurement.
Triangle	Better frequency resolution.	Narrow band signal with stronger interference noise.

## 8. Select FFT Mode

Press **Mode** to set the data source of the FFT operation to "Trace" or "Memory\*".

- Trace
  - The data source of the FFT operation is the data of the waveform displayed on the screen; the length is up to 1200 points.
  - The FFT sample rate is the screen sample rate (namely 100/horizontal time base).
- Memory\*
  - The data source of the FFT operation is the data of the waveform in the memory; the length is up to 16384 points. When the memory depth doesn't exceed 16384 points, all of the data is used for FFT operation. Otherwise, the instrument will read data of 16384 points according to the trigger position; the read rule is as follows:
    - If the trigger position is before the start point of the memory, the instrument will read the data of 16384 points from the start point of the memory.

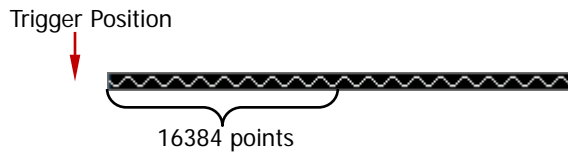

- If the trigger position is in the memory and the number of the points from the trigger point to the end point of the memory is greater than or equal to 16384, the instrument will read the data of 16384 points from the trigger point.

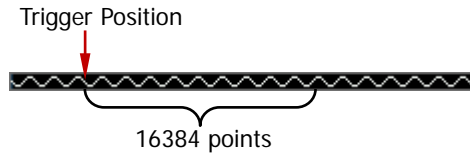

- If the trigger position is in the memory and the number of the points from the trigger point to the end point of the memory is less than 16384, the instrument will read the data of the last 16384 points.

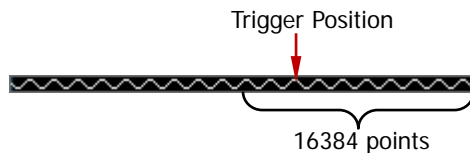

- The FFT sample rate is the memory sample rate.

**Note:** The memory mode is only available in YT time base mode and not slow sweep mode.

## 9. Set the Display Mode

Press **View** to select "Half" (default) or "Full" display mode.

- Half: the source channel and the FFT operation results are displayed separately. The time domain and frequency domain signals are displayed clearly.
- Full: the source channel and the FFT operation results are displayed in the same window to view the frequency spectrum more clearly and to perform more precise measurement.

## 10. Set the Vertical Unit

The vertical unit can be selected as dB/dBm or Vrms. Press **Unit** to select the desired unit and the default is dB/dBm. dB/dBm and Vrms use logarithmic mode and linear mode to display vertical amplitude respectively. If you need to display the FFT frequency spectrum in a relatively larger dynamic range, dB/dBm is recommended.

11. Press **Scale Reset** to adjust the vertical scale of the operation results to the optimal value according to the current configuration.

**Tips**

- You can adjust the center frequency and horizontal scale at the same time using **HORIZONTAL  SCALE**.
- Signals with DC components or deviation would cause error or deviation of the FFT waveform components. To reduce the DC components, set the "**Channel Coupling**" to "AC".
- To reduce the random noise and aliasing frequency components of repetitive or single pulse, set the "**Acquisition Mode**" of the oscilloscope to "Average".

## "AND" Operation







Perform logic "AND" operation on the waveform voltage values of the specified sources point by point and display the results. In operation, when the voltage value of the source channel is greater than the threshold of the corresponding channel, it is regarded as logic "1"; otherwise logic "0".

The results of logic **AND** operation of two binary bits are as follows.

Table 6-2 Logic "AND" Operation

A	B	A&&B
0	0	0
0	1	0
1	0	0
1	1	1

Press **MATH** → **Math** → **Operator** to select "A&&B":

- Press **Operation** to enable or disable the "AND" operation function.
- Press **SourceA** and **SourceB** to select the desired channels (CH1-CH4 or D0-D15).
  - If source A selects any channel in CH1-CH4, press **Thre.A** and use  set the threshold of source A in logic operation. If source A selects any channel in D0-D15, **Thre.A** will be hidden automatically.
  - If source B selects any channel in CH1-CH4, press **Thre.B** and use  set the threshold of source B in logic operation. If source B selects any channel in D0-D15, **Thre.B** will be hidden automatically.
- Press **Offset** and use  to adjust the vertical position of the operation results.
- Press **Scale** and use  to adjust the vertical scale of the operation results.
- Press **Scale Reset** to adjust the vertical scale of the operation results to the optimal value according to the current configuration.
- Press **Options** to set the start and end points of the operation results, enable or disable waveform invert, etc.
  - Press **Start** and use  to set the start point of the operation results.
  - Press **End** and use  to set the end point of the operation results.
  - Press **Invert** to enable or disable the inverted display function of the waveform.
  - Press **Sens.** and use  to set the sensitivity of the digital signal converted from the analog signal on the source. The setting range is from 0 Div to 0.96 Div.
  - Press **Auto Scale** to enable or disable the auto scale function. When auto scale is enabled, the instrument will adjust the vertical scale of the operation results to the optimal value according to the current configuration.

**Note:** **Smooth** is grayed out and disabled. It is only available for differential operation.

- You can also use **HORIZONTAL**  **POSITION** and **HORIZONTAL**  **SCALE** to adjust the horizontal position and scale of the operation results.

## "OR" Operation







Perform logic "OR" operation on the waveform voltage values of the specified sources point by point and display the results. In operation, when the voltage value of the source channel is greater than the threshold of the corresponding channel, it is regarded as logic "1"; otherwise logic "0".

The results of logic **OR** operation of two binary bits are as follows.

Table 6-3 Logic "OR" Operation

A	B	A  B
0	0	0
0	1	1
1	0	1
1	1	1

Press **MATH** → **Math** → **Operator** to select "A||B":

- Press **Operation** to enable or disable the "OR" operation function.
- Press **SourceA** and **SourceB** to select the desired channels (CH1-CH4 or D0-D15).
  - If source A selects any channel in CH1-CH4, press **Thre.A** and use  set the threshold of source A in logic operation. If source A selects any channel in D0-D15, **Thre.A** will be hidden automatically.
  - If source B selects any channel in CH1-CH4, press **Thre.B** and use  set the threshold of source B in logic operation. If source B selects any channel in D0-D15, **Thre.B** will be hidden automatically.
- Press **Offset** and use  to adjust the vertical position of the operation results.
- Press **Scale** and use  to adjust the vertical scale of the operation results.
- Press **Scale Reset** to adjust the vertical scale of the operation results to the optimal value according to the current configuration.
- Press **Options** to set the start and end points of the operation results, enable or disable waveform invert, etc.
  - Press **Start** and use  to set the start point of the operation results.
  - Press **End** and use  to set the end point of the operation results.
  - Press **Invert** to enable or disable the inverted display function of the waveform.
  - Press **Sens.** and use  to set the sensitivity of the digital signal converted

from the analog signal on the source. The setting range is from 0 Div to 0.96 Div.

- Press **Auto Scale** to enable or disable the auto scale function. When auto scale is enabled, the instrument will adjust the vertical scale of the operation results to the optimal value according to the current configuration.

**Note:** **Smooth** is grayed out and disabled. It is only available for differential operation.

- You can also use **HORIZONTAL**  **POSITION** and **HORIZONTAL**  **SCALE** to adjust the horizontal position and scale of the operation results.

## "XOR" Operation





Perform logic "XOR" operation on the waveform voltage values of the specified sources point by point and display the results. In operation, when the voltage value of the source channel is greater than the threshold of the corresponding channel, it is regarded as logic "1"; otherwise logic "0".

The results of logic **XOR** operation of two binary bits are as follows.



Table 6-4 Logic "XOR" Operation

A	B	A^B
0	0	0
0	1	1
1	0	1
1	1	0



Press **MATH** → **Math** → **Operator** to select "A^B":

- Press **Operation** to enable or disable the "XOR" operation function.
- Press **SourceA** and **SourceB** to select the desired channels (CH1-CH4 or D0-D15).
  - If source A selects any channel in CH1-CH4, press **Thre.A** and use  set the threshold of source A in logic operation. If source A selects any channel in D0-D15, **Thre.A** will be hidden automatically.
  - If source B selects any channel in CH1-CH4, press **Thre.B** and use  set the threshold of source B in logic operation. If source B selects any channel in D0-D15, **Thre.B** will be hidden automatically.
- Press **Offset** and use  to adjust the vertical position of the operation results.
- Press **Scale** and use  to adjust the vertical scale of the operation results.
- Press **Scale Reset** to adjust the vertical scale of the operation results to the optimal value according to the current configuration.
- Press **Options** to set the start and end points of the operation results, enable or

disable waveform invert, etc.

- Press **Start** and use  to set the start point of the operation results.
- Press **End** and use  to set the end point of the operation results.
- Press **Invert** to enable or disable the inverted display function of the waveform.
- Press **Sens.** and use  to set the sensitivity of the digital signal converted from the analog signal on the source. The setting range is from 0 Div to 0.96 Div.
- Press **Auto Scale** to enable or disable the auto scale function. When auto scale is enabled, the instrument will adjust the vertical scale of the operation results to the optimal value according to the current configuration.

**Note:** **Smooth** is grayed out and disabled. It is only available for differential operation.

- Use **HORIZONTAL**  **POSITION** and **HORIZONTAL**  **SCALE** can also be used to adjust the horizontal position and scale of the operation results.

## "NOT" Operation



Perform logic "NOT" operation on the waveform voltage values of the specified sources point by point and display the results. In operation, when the voltage value of the source channel is greater than the threshold of the corresponding channel, it is regarded as logic "1"; otherwise logic "0".

The results of logic **NOT** operation of one binary bit are as follows.

Table 6-5 Logic "NOT" Operation



A	!A
0	1
1	0

Press **MATH** → **Math** → **Operator** to select "IA":

- Press **Operation** to enable or disable the "NOT" operation function.
- Press **SourceA** to select the desired channels (CH1-CH4 or D0-D15).  
If source A selects any channel in CH1-CH4, press **Thre.A** and use  set the threshold of source A in logic operation. If source A selects any channel in D0-D15, **Thre.A** will be hidden automatically.
- Press **Offset** and use  to adjust the vertical position of the operation results.
- Press **Scale** and use  to adjust the vertical scale of the operation results.
- Press **Scale Reset** to adjust the vertical scale of the operation results to the optimal value according to the current configuration.
- Press **Options** to set the start and end points of the operation results, enable or



disable waveform invert, etc.

- Press **Start** and use  to set the start point of the operation results.
- Press **End** and use  to set the end point of the operation results.
- Press **Invert** to enable or disable the inverted display function of the waveform.
- Press **Sens.** and use  to set the sensitivity of the digital signal converted from the analog signal on the source. The setting range is from 0 Div to 0.96 Div.
- Press **Auto Scale** to enable or disable the auto scale function. When auto scale is enabled, the instrument will adjust the vertical scale of the operation results to the optimal value according to the current configuration.





**Note:** **Smooth** is grayed out and disabled. It is only available for differential operation.

- You can also use **HORIZONTAL**  **POSITION** and **HORIZONTAL**  **SCALE** to adjust the horizontal position and scale of the operation results.

## Intg

Calculate the integral of the selected source. You can use integral to measure the area under a waveform or the pulse energy.

Press **MATH** → **Math** → **Operator** to select "Intg":

- Press **Operation** to enable or disable the "Intg" operation function.
- Press **Source** to select the desired channel (CH1, CH2, CH3, CH4 or fx (please refer to the introduction in "Fx Operation")).
- Press **Offset** and use  to adjust the vertical position of the operation results.
- Press **Scale** and use  to adjust the vertical scale of the operation results.
- Press **Scale Reset** to adjust the vertical scale of the operation results to the optimal value according to the current configuration.
- Press **Options** to set the start and end points of the operation results, enable or disable waveform invert, etc.
  - Press **Start** and use  to set the start point of the operation results.
  - Press **End** and use  to set the end point of the operation results.
  - Press **Invert** to enable or disable the inverted display function of the waveform.
  - Press **Auto Scale** to enable or disable the auto scale function. When auto scale is enabled, the instrument will adjust the vertical scale of the operation results to the optimal value according to the current configuration.
  - Press **fx Operator**, **fx A** and **fx B** to set the operator and signal sources of

the inner layer operation of Fx operation (please refer to the introduction in "Fx Operation").





**Note:** **Sens.** and **Smooth** are grayed out and disabled. **Sens.** is only available when a digital channel is selected as the source. **Smooth** is only available for differential operation.

- You can also use **HORIZONTAL**  **POSITION** and **HORIZONTAL**  **SCALE** to adjust the horizontal position and scale of the operation results.

## Diff

Calculate the discrete time differentiate of the selected source. For example, you can use differentiate to calculate the instantaneous slope of a waveform.

Press **MATH** → **Math** → **Operator** to select "Diff":

- Press **Operation** to enable or disable the "Diff" operation function.
- Press **Source** to select the desired channel (CH1, CH2, CH3, CH4 or fx (please refer to the introduction in "Fx Operation")).
- Press **Offset** and use  to adjust the vertical position of the operation results.
- Press **Scale** and use  to adjust the vertical scale of the operation results.
- Press **Scale Reset** to adjust the vertical scale of the operation results to the optimal value according to the current configuration.
- Press **Options** to set the start and end points of the operation results, enable or disable waveform invert, etc.
  - Press **Start** and use  to set the start point of the operation results.
  - Press **End** and use  to set the end point of the operation results.
  - Press **Invert** to enable or disable the inverted display function of the waveform.
  - Press **Smooth** to set the smoothing window width of differential operation. The setting range is from 3 to 201. The smoothing window is rectangular which can increase the smoothing for differential operation.
  - Press **Auto Scale** to enable or disable the auto scale function. When auto scale is enabled, the instrument will adjust the vertical scale of the operation results to the optimal value according to the current configuration.
  - Press **fx Operator**, **fx A** and **fx B** to set the operator and signal sources of the inner layer operation of Fx operation (please refer to the introduction in "Fx Operation").

**Note:** **Sens.** is grayed out and disabled. It is only available when a digital channel is selected as source.

- You can also use **HORIZONTAL**  **POSITION** and **HORIZONTAL**  **SCALE** to adjust the horizontal position and scale of the operation results.







**Tip**

Because the differential operation is very sensitive to noise, you can set the "Acquisition Mode" to "Average".

## Sqrt

Calculate the square root of the selected source point by point and display the results. When the operation is invalid, "NAN" is displayed at the bottom of the screen.

Press **MATH** → **Math** → **Operator** to select "Sqrt":







- Press **Operation** to enable or disable the "Sqrt" operation function.
  - Press **Source** to select the desired channel (CH1, CH2, CH3, CH4 or fx (please refer to the introduction in "Fx Operation")).
  - Press **Offset** and use  to adjust the vertical position of the operation results.
  - Press **Scale** and use  to adjust the vertical scale of the operation results.
  - Press **Scale Reset** to adjust the vertical scale of the operation results to the optimal value according to the current configuration.
  - Press **Options** to set the start and end points of the operation results, enable or disable waveform invert, etc.
    - Press **Start** and use  to set the start point of the operation results.
    - Press **End** and use  to set the end point of the operation results.
    - Press **Invert** to enable or disable the inverted display function of the waveform.
    - Press **Auto Scale** to enable or disable the auto scale function. When auto scale is enabled, the instrument will adjust the vertical scale of the operation results to the optimal value according to the current configuration.
    - Press **fx Operator**, **fx A** and **fx B** to set the operator and signal sources of the inner layer operation of Fx operation (please refer to the introduction in "Fx Operation").
- Note:** **Sens.** and **Smooth** are grayed out and disabled. **Sens.** is only available when a digital channel is selected as the source. **Smooth** is only available for differential operation.
- You can also use **HORIZONTAL**  **POSITION** and **HORIZONTAL**  **SCALE** to adjust the horizontal position and scale of the operation results.

## Lg (Use 10 as the Base)

Calculate the logarithm of the selected source (use10 as the base) point by point and display the results. When the operation is invalid, "NAN" is displayed at the bottom of

the screen.



Press **MATH** → **Math** → **Operator** to select "Lg":





- Press **Operation** to enable or disable the "Lg" operation function.
  - Press **Source** to select the desired channel (CH1, CH2, CH3, CH4 or fx (please refer to the introduction in "Fx Operation")).
  - Press **Offset** and use  to adjust the vertical position of the operation results.
  - Press **Scale** and use  to adjust the vertical scale of the operation results.
  - Press **Scale Reset** to adjust the vertical scale of the operation results to the optimal value according to the current configuration.
  - Press **Options** to set the start and end points of the operation results, enable or disable the inverted waveform, etc.
    - Press **Start** and use  to set the start point of the operation results.
    - Press **End** and use  to set the end point of the operation results.
    - Press **Invert** to enable or disable the inverted display function of the waveform.
    - Press **Auto Scale** to enable or disable the auto scale function. When auto scale is enabled, the instrument will adjust the vertical scale of the operation results to the optimal value according to the current configuration.
    - Press **fx Operator**, **fx A** and **fx B** to set the operator and signal sources of the inner layer operation of Fx operation (please refer to the introduction in "Fx Operation").
- Note:** **Sens.** and **Smooth** are grayed out and disabled. **Sens.** is only available when a digital channel is selected as the source. **Smooth** is only available for differential operation.
- You can also use **HORIZONTAL**  **POSITION** and **HORIZONTAL**  **SCALE** to adjust the horizontal position and scale of the operation results.

## Ln

Calculate the natural logarithm of the selected source point by point and display the results. When the operation is invalid, "NAN" is displayed at the bottom of the screen.

Press **MATH** → **Math** → **Operator** to select "Ln":





- Press **Operation** to enable or disable the "Ln" operation function.
- Press **Source** to select the desired channel (CH1, CH2, CH3, CH4 or fx (please refer to the introduction in "Fx Operation")).
- Press **Offset** and use  to adjust the vertical position of the operation results.
- Press **Scale** and use  to adjust the vertical scale of the operation results.
- Press **Scale Reset** to adjust the vertical scale of the operation results to the

- optimal value according to the current configuration.
- Press **Options** to set the start and end points of the operation results, enable or disable waveform invert, etc.
    - Press **Start** and use  to set the start point of the operation results.
    - Press **End** and use  to set the end point of the operation results.
    - Press **Invert** to enable or disable the inverted display function of the waveform.
    - Press **Auto Scale** to enable or disable the auto scale function. When auto scale is enabled, the instrument will adjust the vertical scale of the operation results to the optimal value according to the current configuration.
    - Press **fx Operator**, **fx A** and **fx B** to set the operator and signal sources of the inner layer operation of Fx operation (please refer to the introduction in "Fx Operation").
- Note:** **Sens.** and **Smooth** are grayed out and disabled. **Sens.** is only available when a digital channel is selected as the source. **Smooth** is only available for differential operation.
- You can also use **HORIZONTAL**  **POSITION** and **HORIZONTAL**  **SCALE** to adjust the horizontal position and scale of the operation results.

## Exp

Calculate the exponent of the selected source point by point and display the results.

Press **MATH** → **Math** → **Operator** to select "Exp":

- Press **Operation** to enable or disable the "Exp" operation function.
- Press **Source** to select the desired channel (CH1, CH2, CH3, CH4 or fx (please refer to the introduction in "Fx Operation")).
- Press **Offset** and use  to adjust the vertical position of the operation results.
- Press **Scale** and use  to adjust the vertical scale of the operation results.
- Press **Scale Reset** to adjust the vertical scale of the operation results to the optimal value according to the current configuration.
- Press **Options** to set the start and end points of the operation results, enable or disable waveform invert, etc.
  - Press **Start** and use  to set the start point of the operation results.
  - Press **End** and use  to set the end point of the operation results.
  - Press **Invert** to enable or disable the inverted display function of the waveform.
  - Press **Auto Scale** to enable or disable the auto scale function. When auto scale is enabled, the instrument will adjust the vertical scale of the operation results to the optimal value according to the current

configuration.

- Press **fx Operator**, **fx A** and **fx B** to set the operator and signal sources of the inner layer operation of Fx operation (please refer to the introduction in "Fx Operation").





**Note:** **Sens.** and **Smooth** are grayed out and disabled. **Sens.** is only available when a digital channel is selected as the source. **Smooth** is only available for differential operation.

- You can also use **HORIZONTAL**  **POSITION** and **HORIZONTAL**  **SCALE** to adjust the horizontal position and scale of the operation results.

## Abs

Calculate the absolute value of the selected source and display the results.

Press **MATH** → **Math** → **Operator** to select "Abs":

- Press **Operation** to enable or disable the "Abs" operation function.
- Press **Source** to select the desired channel (CH1, CH2, CH3, CH4 or fx (please refer to the introduction in "Fx Operation")).
- Press **Offset** and use  to adjust the vertical position of the operation results.
- Press **Scale** and use  to adjust the vertical scale of the operation results.
- Press **Scale Reset** to adjust the vertical scale of the operation results to the optimal value according to the current configuration.
- Press **Options** to set the start and end points of the operation results, enable or disable waveform invert, etc.
  - Press **Start** and use  to set the start point of the operation results.
  - Press **End** and use  to set the end point of the operation results.
  - Press **Invert** to enable or disable the inverted display function of the waveform.
  - Press **Auto Scale** to enable or disable the auto scale function. When auto scale is enabled, the instrument will adjust the vertical scale of the operation results to the optimal value according to the current configuration.
  - Press **fx Operator**, **fx A** and **fx B** to set the operator and signal sources of the inner layer operation of Fx operation (please refer to the introduction in "Fx Operation").





**Note:** **Sens.** and **Smooth** are grayed out and disabled. **Sens.** is only available when a digital channel is selected as the source. **Smooth** is only available for differential operation.

- You can also use **HORIZONTAL**  **POSITION** and **HORIZONTAL**  **SCALE** to adjust the horizontal position and scale of the operation results.

## Filter



MSO1000Z/DS1000Z provides 4 types of filters (Low Pass Filter, High Pass Filter, Band Pass Filter and Band Stop Filter). The specified frequencies can be filtered by setting the bandwidth.



Press **MATH** → **Math** → **Operator** to select "Filter":

- Press **Operation** to enable or disable the "Filter" operation function.
- Press **Source** to select the desired channel (CH1, CH2, CH3 or CH4).
- Press **Offset** and use  to adjust the vertical position of the operation results.
- Press **Scale** and use  to adjust the vertical scale of the operation results.
- Press **Scale Reset** to adjust the vertical scale of the operation results to the optimal value according to the current configuration.
- Press **Filter** to select the desired filter type.
  - : low pass, namely only the signals whose frequencies are lower than the current cutoff frequency (**ωc1**) can pass the filter.
  - : high pass, namely only the signals whose frequencies are greater than the current cutoff frequency (**ωc1**) can pass the filter.
  - : band pass, namely only the signals whose frequencies are greater than the current cutoff frequency 1 (**ωc1**) and lower than the current cutoff frequency 2 (**ωc2**) can pass the filter.
 

**Note:** The cutoff frequency 1 (**ωc1**) must be lower than the cutoff frequency 2 (**ωc2**).
  - : band stop, namely only the signals whose frequencies are lower than the current cutoff frequency 1 (**ωc1**) or greater than the current cutoff frequency 2 (**ωc2**) can pass the filter.
 

**Note:** The cutoff frequency 1 (**ωc1**) must be lower than the cutoff frequency 2 (**ωc2**).
- When "low pass" or "high pass" filter is selected, you need to set cutoff frequency. Press **ωc1** and use  to adjust the cutoff frequency.
 

When "band pass" or "band stop" filter is selected, you need to set 2 cutoff frequencies. Press **ωc1** and use  to adjust the cutoff frequency 1; press **ωc2** and use  to adjust the cutoff frequency 2.

**Note:** The settable range of the bandwidth is related to the current horizontal time base.
- Press **Options** to set the start and end points of the operation results, enable or disable waveform invert, etc.
  - Press **Start** and use  to set the start point of the operation results.
  - Press **End** and use  to set the end point of the operation results.
  - Press **Invert** to enable or disable the inverted display function of the waveform.

- Press **Auto Scale** to enable or disable the auto scale function. When auto scale is enabled, the instrument will adjust the vertical scale of the operation results to the optimal value according to the current configuration.

**Note:** **Sens.** and **Smooth** are grayed out and disabled. **Sens.** is only available when a digital channel is selected as the source. **Smooth** is only available for differential operation.

- You can also use **HORIZONTAL**  **POSITION** and **HORIZONTAL**  **SCALE** to adjust the horizontal position and scale of the operation results.

## Fx Operation

MSO1000Z/DS1000Z supports the fx operation function which can achieve more complex operations.

The procedures are as follows:

1. Split the complex operation  
Users can split a more complex operation into inner and outer layers (the inner layer can only be one of the algebra operations; the outer layer can be one of the algebra or function operations) according to their needs.
2. Set the operator and signal sources of the inner layer  
Press **MATH** → **Math** → **Options** → **fx Operator** select "A+B", "A-B", "A×B" or "A/B". Press **fx A** or **fx B** to select the source A and source B of the inner layer operation respectively.
3. Set the operator and signal source of the outer layer  
Press **MATH** → **Math** → **Operator** to select the desired operator. The outer layer supports multiple operations, including A+B, A-B, A×B, A/B, Intg, Diff, Sqrt, Lg, Ln, Exp and Abs. Then, you can set the result ("fx") of the inner layer operation as the signal source of the outer layer operation.

For example, Intg(CH1\*CH2). The procedure is as follows:

Press **MATH** → **Math** → **Options** → **fx Operator** to select "A×B". Press **fx A** to select "CH1" and press **fx B** to select "CH2". At this point, the inner layer operation setting is completed. Press **MATH** → **Math** → **Operator** to select "Intg". You can set the parameters of the function operation (Intg). Press **Operation** to select "ON" and press **Source** to select "fx".



## Math Operation Label

Press **MATH** → **Math** → **Label** → **Display** to enable or disable the MATH label. When "ON" is selected, you can add the MATH label via two modes.

- **To Use Preset Label**

Press **Preset** to select ADD, SUB, MUL, DIV, FFT, AND, OR, XOR, NOT, Intg, Diff, Sqrt, Lg, Ln, Exp, Abs, LPas, HPas, BPas or BStop.

- **To Edit Label Manually**

Press **Label Edit** to open the label input interface. You can input the label manually. For the details, please refer to the introduction in "**Channel Label**".

## Auto Measurement

MSO1000Z/DS1000Z provides auto measurements of 37 waveform parameters and the statistics and analysis of the measurement results. What's more, you can also use the frequency counter to realize more precise frequency measurement.

### Quick Measurement after AUTO

When the oscilloscope is correctly connected and has detected valid input signal, press **AUTO** to enable the waveform auto setting function and open the following function menu:



The image shows a vertical menu of buttons. From top to bottom: a square button with a square wave icon; a square button with a sine wave icon; a square button with a rising edge icon; a square button with a falling edge icon; a rectangular button with the text 'Back' and a left-pointing arrow; a rectangular button with the text 'Undo' and a circular arrow icon.

**Single-period:** set the oscilloscope to display single-period signal automatically. Measure the "Period" and "Frequency" of the current signal within a single period and display the measurement results at the bottom of the screen.

**Multi-period:** set the oscilloscope to display multi-period signal automatically. Measure the "Period" and "Frequency" of the current signal within multiple periods and display the measurement results at the bottom of the screen.

**Rise Time:** measure the "Rise Time" of the current signal and display the measurement result at the bottom of the screen.

**Fall Time:** measure the "Fall Time" of the current signal and display the measurement result at the bottom of the screen.

**Back:** return to the menu displayed at the last user setting.

**Undo:** cancel the automatic settings and restore the parameters set by users lastly.

Figure 6-2 Function Menu after AUTO

**Note:** Waveform auto setting function requires that the frequency of sine is no lower than 41 Hz; the duty cycle should be greater than 1% and the amplitude must be at least 20 mVpp for square. Otherwise, the Waveform auto setting function may be invalid and the quick parameter measurement function displayed in the menu will also be unavailable.

## One-key Measurement of 37 Parameters

Press **MENU** at the left of the screen to turn on the measurement menu of the 37 parameters and then press the corresponding menu softkey to quickly realize "One-key" measurement. The measurement results can be displayed at the bottom of the screen in various font sizes (press **Measure** → **Font Size** to select "Normal", "Large" or "Extra Large").

The time and voltage parameters icons in the measurement items and the measurement results on the screen are always marked in the same color with the channel (**Measure** → **Source**) currently used.

The parameter icons and the measurement results of delay and phase are always marked in white. The colors of the numbers (1 and 2) in the icons and results are related to the measurement source currently selected. When the measurement source is an analog channel, the color of 1 or 2 is the same with that of the channel selected. When the measurement source is a digital channel, 1 or 2 is marked in green.

**Note:** If the measurement result is displayed as "\*\*\*\*\*", it means that there is no signal input in the current source or the measurement result is not within the valid range (too large or too small).

## Time Parameters

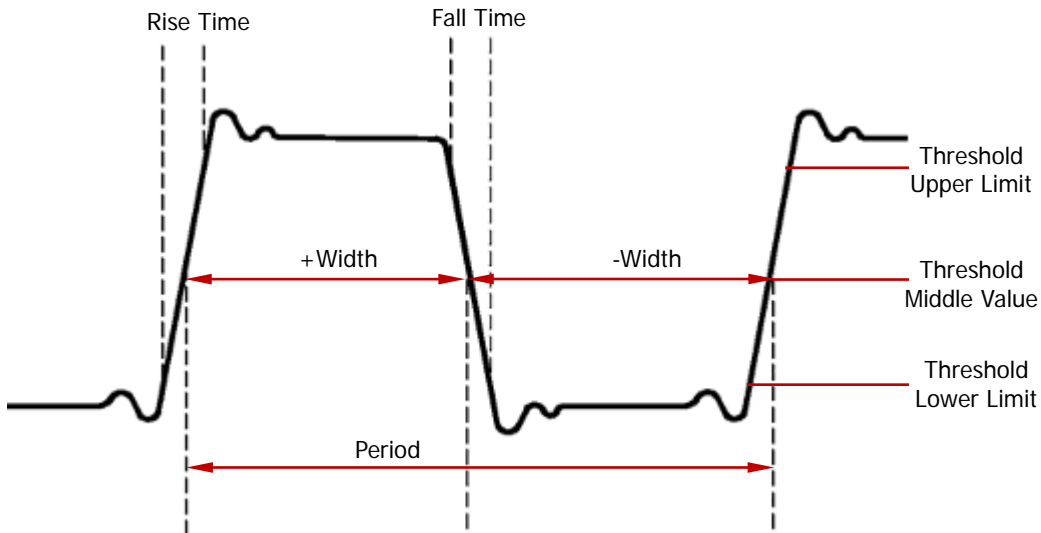

Figure 6-3 Time Parameters

1. **Period:** defined as the time between the middle threshold points of two consecutive, like-polarity edges.
2. **Freq:** defined as the reciprocal of period.
3. **Rise Time:** the time for the signal amplitude to rise from the threshold lower limit to the threshold upper limit.
4. **Fall Time:** the time for the signal amplitude to fall from the threshold upper limit to the threshold lower limit.
5. **+Width:** the time difference between the threshold middle value of a rising edge and the threshold middle value of the next falling edge of the pulse.
6. **-Width:** the time difference between the threshold middle value of a falling edge and the threshold middle value of the next rising edge of the pulse.
7. **+Duty:** the ratio of the positive pulse width to the period.
8. **-Duty:** the ratio of the negative pulse width to the period.
9. **tVmax:** the time corresponding to the waveform maximum value (Vmax).
10. **tVmin:** the time corresponding to the waveform minimum value (Vmin).

**Note:** The default values of the threshold upper limit, threshold middle value and threshold lower limit are 90%, 50% and 10% respectively. You can set them via **Measure** → **Setting** → **Type** → "Threshold" and for the setting method, please refer to the introduction in "**Threshold Measurement Setting**".

## Count Values

1. **+Pulses:** the number of positive pulses that rise from below the threshold lower limit to above the threshold upper limit.

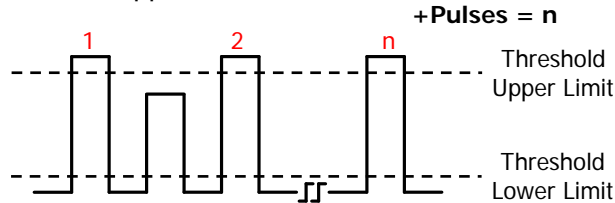

2. **-Pulses:** the number of negative pulses that fall from above the threshold upper limit to below the threshold lower limit.

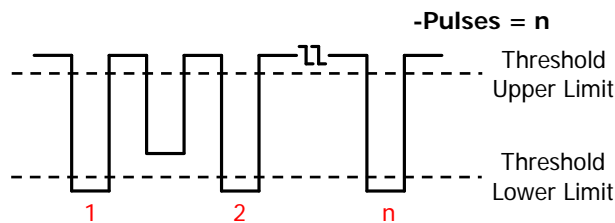

3. **+Edges:** the number of rising edges that rise from below the threshold lower limit to above the threshold upper limit.

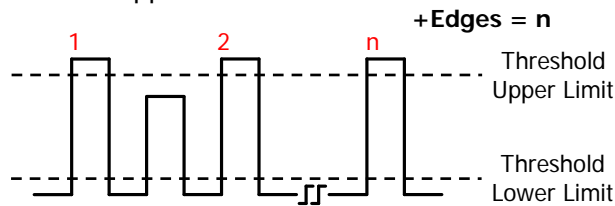

4. **-Edges:** the number of falling edges that fall from above the threshold upper limit to below the threshold lower limit.

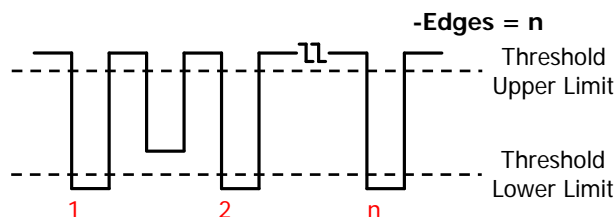

### Note:

- The above measurement items only apply to analog channels.
- The default values of the threshold upper limit and threshold lower limit are 90% and 10% respectively. You can set them via **Measure** → **Setting** → **Type** → "Threshold" and for the setting method, please refer to the introduction in "**Threshold Measurement Setting**".

## Delay and Phase

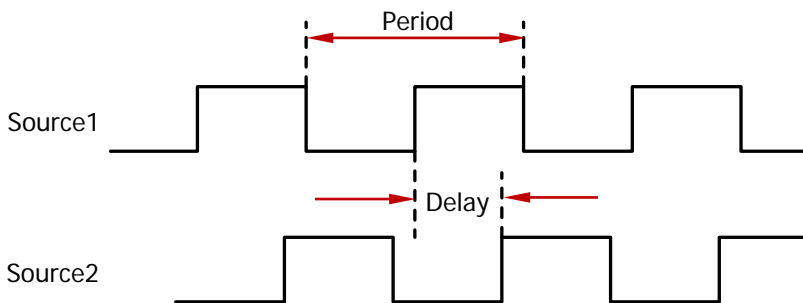

Figure 6-4 Delay and Phase

Source 1 and source 2, the same as source A and source B in the measurement setting menu can be any channel of CH1-CH4 or D0-D15. For the setting method, please refer to the introduction in "**Measurement Setting**".

1. **Delay  $f1 \rightarrow 2$** : the time difference between the rising edges of source 1 and source 2. Negative delay indicates that the selected rising edge of source 1 occurred after that of source 2.
2. **Delay  $\bar{f}1 \rightarrow 2$** : the time difference between the falling edges of source 1 and source 2. Negative delay indicates that the selected falling edge of source 1 occurred after that of source 2.
3. **Phase  $f1 \rightarrow 2$** : phase difference calculated according to "**Delay  $f1 \rightarrow 2$** " and the period of source 1, expressed in degree. The calculation formula is as shown in equation (6-1).
4. **Phase  $\bar{f}1 \rightarrow 2$** : phase difference calculated according to "**Delay  $\bar{f}1 \rightarrow 2$** " and the period of source 1, expressed in degree. The calculation formula is as shown in equation (6-1).

The phase calculation formula:

$$Phase = \frac{Delay}{Period1} \times 360^\circ \quad (6-1)$$

Wherein,

*Phase* represents "**Phase  $f1 \rightarrow 2$** " or "**Phase  $\bar{f}1 \rightarrow 2$** "

*Delay* represents "**Delay  $f1 \rightarrow 2$** " or "**Delay  $\bar{f}1 \rightarrow 2$** "

*Period1* represents the period of source 1

## Voltage Parameters

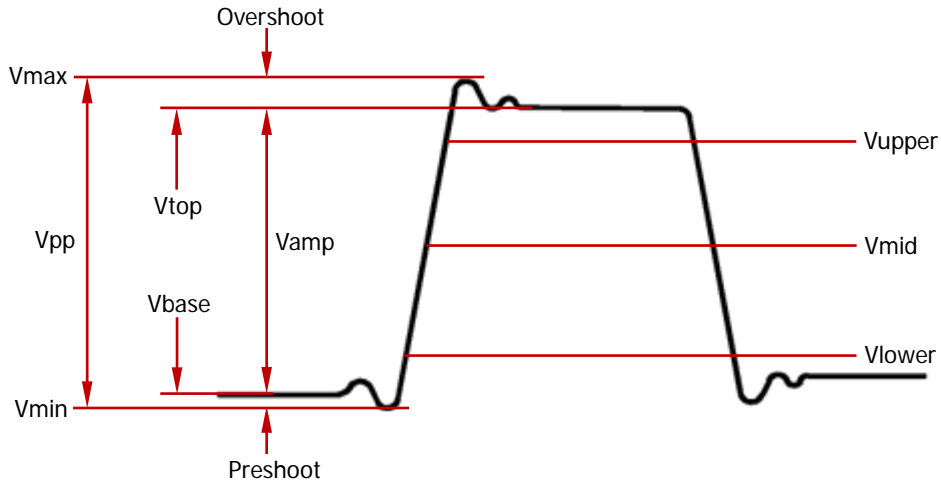

Figure 6-5 Voltage Parameters

1. **Vmax**: the voltage value from the highest point of the waveform to the GND.
2. **Vmin**: the voltage value from the lowest point of the waveform to the GND.
3. **Vpp**: the voltage value from the highest point to the lowest point of the waveform.
4. **Vtop**: the voltage value from the flat top of the waveform to the GND.
5. **Vbase**: the voltage value from the flat base of the waveform to the GND.
6. **Vamp**: the voltage value from the top of the waveform to the base of the waveform.
7. **Vupper**: the actual voltage value corresponding to the threshold maximum value.
8. **Vmid**: the actual voltage value corresponding to the threshold middle value.
9. **Vlower**: the actual voltage value corresponding to the threshold minimum value.
10. **Vavg**: the arithmetic average value on the whole waveform or on the gating area. The calculation formula is as follows:

$$Average = \frac{\sum x_i}{n} \quad (6-2)$$

Wherein,  $x_i$  is the measurement result of the  $i$ th point,  $n$  is the number of points being measured.

11. **Vrms**: the root mean square value on the whole waveform or the gating area. The calculation formula is as follows.

- 12. Per.Vrms:** the root mean square value within a period. The calculation formula is as follows.

$$RMS = \sqrt{\frac{\sum_{i=1}^n x_i^2}{n}} \quad (6-3)$$

Wherein,  $x_i$  is the measurement result of the  $i$  th point,  $n$  is the number of points being measured.

- 13. Overshoot:** the ratio of the difference of the maximum value and top value of the waveform to the amplitude value.
- 14. Preshoot:** the ratio of the difference of the minimum value and base value of the waveform to the amplitude value.
- 15. Variance:** the average of the sum of the squares for the difference between the amplitude value of each waveform point and the waveform average value on the whole waveform or on the gating area. The variance reflects the fluctuation degree of the waveform. The calculation formula is as follows:

$$Variance = \frac{\sum_{i=1}^n (Vamp(i) - Average)^2}{n} \quad (6-4)$$

Wherein,  $Vamp(i)$  is the amplitude of the  $i$  th point,  $Average$  is the waveform average value,  $n$  is the number of points being measured.

## Other Parameters

- +Rate:** divide the difference of the upper value and lower value on the rising edge by the corresponding time.
- Rate:** divide the difference of the lower value and upper value on the falling edge by the corresponding time.
- Area:** the area of the whole waveform within the screen and the unit is Vs. The area of the waveform above the zero reference (namely the vertical offset) is positive and the area of the waveform below the zero reference is negative. The area measured is the algebraic sum of the area of the whole waveform within the screen.
- Per.Area:** the area of the first period of waveform on the screen and the unit is Vs. The area of the waveform above the zero reference (namely the vertical offset) is positive and the area of the waveform below the zero reference is negative. The area measured is the algebraic sum of the area of the whole period waveform.



## Frequency Counter Measurement

The hardware frequency counter supplied with MSO1000Z/DS1000Z oscilloscope can make more precise measurement of the input signal frequency.

Press **Measure** → **Counter** to select CH1-CH4 or D0-D15 as the measurement source. The measurement result is displayed at the upper right corner of the screen and you can identify the current measurement source according to the color of the icon and channel number. The following figure is the result of the frequency measurement of the input signal of CH1.



Select "OFF" to disable the frequency counter measurement function.

**Note:** When the frequency of the input signal of the measurement source is lower than 15 Hz, the measurement result is displayed as "<15Hz".



## Measurement Setting

### 1. Source Selection

Press **Measure** → **Source** to select the desired channel for measurement (CH1-CH4, MATH or D0-D15). The color of the parameter icons under **MENU** at the left of the screen will change with the source selected.

### 2. Measurement Range

Press **Measure** → **Range** → **Region** to select the "Screen" region or "Cursor" region for measurement.

When the "Cursor" region is selected, you can press **CursorA** and **CursorB** and then use  to adjust the positions of the two cursor lines respectively to determine the measurement range; or you can press **CursorAB** and use  to adjust the positions of cursor A and cursor B at the same time (the horizontal distance between cursor A and cursor B remains unchanged). During the adjustment, two cursor lines (denote the current positions of the cursors) are displayed on the screen and will disappear about 2 s later after you stop adjusting the cursor position(s).

**Note:** The adjustable range of the position of cursor A (cursor B) is related to the current position of cursor B (cursor A) and the position of cursor A must be lower than that of cursor B. You can press **CursorA**, **CursorB** or **CursorAB** and then press  to quickly set the position of the corresponding cursor to the

minimum value within the settable range.

### 3. Delay Measurement Setting

Specify the source 1 and source 2 in the measurement items "**Delay f1→2**" and "**Delay  $\tau$ 1→2**".

Press **Measure** → **Setting** → **Type** → "Delay" and then press **SourceA** and **SourceB** to set the two channel sources (CH1-CH4 or D0-D15) of delay measurement respectively.

### 4. Phase Measurement Setting



Specify the source 1 and source 2 in the measurement items "**Phase f1→2**" and "**Phase  $\tau$ 1→2**".

Press **Measure** → **Setting** → **Type** → "Phase" and then press **SourceA** and **SourceB** to set the two channel sources (CH1-CH4 or D0-D15) of phase measurement respectively.

### 5. Threshold Measurement Setting

Specify the upper limit, lower limit and middle value of the auto measurement of the analog channel. Measurements of all the time, delay and phase parameters will be influenced by this setting.

Press **Measure** → **Setting** → **Type** → "Threshold" and then:

- Press **Max** and use  to set the upper limit of the measurement. Reducing the upper limit to the current middle value will automatically reduce the middle value and lower limit to keep them lower than the upper limit. The default is 90% and the range available is from 7% to 95%.
- Press **Mid** and use  to set the middle value of measurement. The middle value is limited by the settings of the upper limit and lower limit. The default is 50% and the range available is from 6% to 94%.
- Press **Min** and use  to set the lower limit of the measurement. Increasing the lower limit to the current middle value will automatically increase the middle value and upper limit to keep them higher than the lower limit. The default is 10% and the range available is from 5% to 93%.

## To Clear the Measurement

If you have currently enabled one or more items in the 37 measurement parameters, you can "Delete" or "Recover" the last five parameters. The measurement results of measurement items 1 to 5 are displayed from left to right at the bottom of the screen.

**Note:** The last five parameters are determined according to the order in which you turned them on and they will not change as you delete one or more measurement items.

Press **Measure** → **Clear** → **Item n** (n=1~5) to "Delete" or "Recover" the specified measurement item.

- When the state of **Item n** (n=1~5) is "Delete", you can press **Item n** (n=1~5) to delete the corresponding item. At this point, the Nth measurement result at the bottom of the screen is grayed out. If a new measurement item is opened, all items will move one-item left.
- When the state of **Item n** (n=1~5) is "Recover", you can press **Item n** (n=1~5) to recover the corresponding item. At this point, the Nth measurement result (from the left) at the bottom of the screen is illuminated automatically.

Press **Measure** → **Clear** → **All Items** to "Delete" or "Recover" the last five parameters at the same time. When all measurement items are deleted, all measurement results will be hidden. At this point, you can press **All Items** to recover the last five items deleted at the same time.

**Note:** You can press and hold **Measure** to clear all the measurement items currently turned on. At this point, you can recover the last five parameters turned on by pressing **Measure** → **Clear** → **Item n** (n=1~5) or **Measure** → **Clear** → **All Items**.

## All Measurement

All measurement could measure all the time and voltage parameters (each measurement source has 29 items) of the current measurement source and display the results on the screen. Press **Measure** → **Measure All** to enable or disable the all measurement function. Press **All Measure Source** and use  to select the channel(s) to be measured (CH1-CH4 and MATH).

- When all measurement is enabled, "One-key" measurement is also valid.
- **"To Clear the Measurement"** will not clear the results of all measurement.

## Statistic Function

Make statistic and display the current, average, minimum (or standard deviation) and maximum (or count) values of at most 5 measurement items that are turned on last.

Press **Measure** → **Statistic** to turn the statistic function on or off. When the statistic function is enabled, press **Stat.Sel.** to select "Extremum" or "Difference" measurement. When "Extremum" is selected, minimum and maximum values are displayed. When "Difference" is selected, standard deviation and count values are displayed. Press **Measure** → **Reset Stat.** to clear the history data and make statistic again.



Extremum Measurement

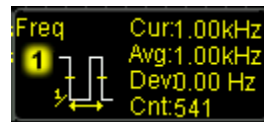

Difference Measurement

## Measurement History

The measurement history function can display the history measurement data of the measurement items currently turned on in graph or table form.

Press **Measure** → **History** → **Disp Type** to select "Graph" or "Table". Press **Measure** → **History** → **DispHistory** to turn on or off the measurement history function. In "Graph" display mode, the oscilloscope draws the measurement value curve in real time with the horizontal axis denoting time and the vertical axis denoting the measurement value. In "Table" display mode, the oscilloscope displays the 8 latest measurement values in real time. As shown in the figures below.

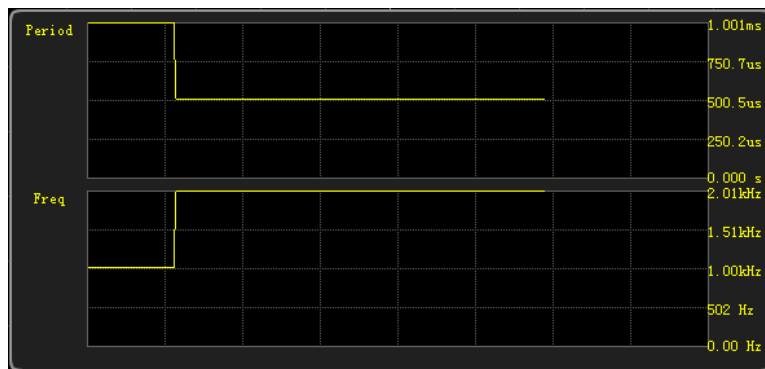

Graph

Meas. Item	Meas. Data							
Period	500.0us	500.0us	500.0us	500.0us	500.0us	500.0us	500.0us	500.0us
Freq	2.00kHz	2.00kHz	2.00kHz	2.00kHz	2.00kHz	2.00kHz	2.00kHz	2.00kHz

Table

## Measurement Result Display Type

The measurement results can be displayed at the bottom of the screen in various font sizes. Press **Measure** → **Font Size** to select "Normal", "Large" or "Extra Large".

- When "Normal" is selected, the measurement results of at most 5 measurement items that are turned on last can be displayed at the bottom of the screen.
- When "Large" or "Extra Large" is selected, the number of measurement results can be displayed at the bottom of the screen will be affected. At this point, you can press **Sel.Item** and use  to select the measurement item to be viewed.

**Note:** **Sel.Item** is not available when no measurement item is turned on.

## Cursor Measurement

Cursor measurement can measure the X axis values (usually Time) and Y axis values (usually Voltage) of the selected waveform. Before making cursor measurement, connect the signal to the oscilloscope and acquire stable display. All the parameters supported by the "Auto Measurement" function can be measured through cursors.

Press **Cursor** → **Mode** at the front panel and use  to select the desired cursor mode (the default is "OFF") and then press down the knob. The modes available are "Manual", "Track" and "Auto". When the **Time Base Mode** is set to XY, you can select the XY cursor measurement mode.

### Manual Mode

In this mode, a pair of cursors will appear. You can adjust the cursors manually to measure the X (or Y), X increment (or Y increment) between cursors and the reciprocal of X increment on the waveform of the selected source (CH1-CH4, LA or MATH). When the measurement source is set to LA, the logic level value of the digital channel currently turned on will be displayed in hexadecimal forms (high level is 1 and low level is 0).

Press **Cursor** → **Mode** → "Manual" to turn the manual cursor function on. To easily read data, the display form of measurement results on the upper left corner of the screen changes with the measurement source and unit selected.

When the measurement source is set to CH1-CH4 or MATH:

- When the measurement source is set to FFT (press **MATH** → **Math** → **Operator** → "FFT" and press **Operation** to select "ON"; press **Cursor** → **Source** → "MATH") and the horizontal unit is set to "Hz", the form of the measurement results is as shown in figure (a).
- When the measurement source is non-FFT and the horizontal unit is set to "s", the form of the measurement results is as shown in figure (b).

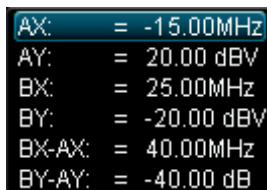

```

AX: = -15.00MHz
AY: = 20.00 dBV
BX: = 25.00MHz
BY: = -20.00 dBV
BX-AX: = 40.00MHz
BY-AY: = -40.00 dB
  
```

Figure (a)



```

AX: = -400.0us
AY: = 20.00 V
BX: = 400.0us
BY: = -20.00 V
BX-AX: = 800.0us
BY-AY: = -40.00 V
1/|dX|: = 1.250kHz
  
```

Figure (b)

- AX: the X value at cursor A. X value takes the trigger position as reference. Its unit is "s" or "Hz" (when measuring FFT waveform).
- AY: the Y value at cursor A. Y value takes the channel GND of CH1 as reference. Its unit is the same as that of the current signal source.
- BX: the X value at cursor B. X value takes the trigger position as reference. Its unit is "s" or "Hz" (when measuring FFT waveform).

- BY: the Y value at cursor B. Y value takes the channel GND of CH1 as reference. Its unit is the same as that of the current signal source.
- BX-AX: the horizontal difference between cursors A and B.
- BY-AY: the vertical difference between cursors A and B.
- $|dX|$ : when the horizontal unit is set to "s",  $|dX|$  represents the time difference between cursor A and cursor B; when the horizontal unit is set to "Hz",  $|dX|$  represents the frequency difference between cursor A and cursor B.
- $1/|dX|$ : the frequency difference between cursor A and cursor B.

When the measurement source is set to LA, the form of the measurement results is as shown in the figure below if the horizontal unit is set to "s".

```
AX:      = -20.00ns
D15-D0: = 0X 0000
BX:      = 280.0ns
D15-D0: = 0X 0000
BX-AX:   = 280.0ns
1/|dX|:  = 3.571MHz
```

- AX: the X value at cursor A. X value takes the trigger position as reference.
- D15-D0: display the logic level values at cursor A (D15-D0 from left to right) in hexadecimal forms. If the digital channel is currently turned off, it will be denoted by "\*".
- BX: the X value at cursor B. X value takes the trigger position as reference.
- D15-D0: display the logic level values at cursor B (D15-D0 from left to right) in hexadecimal forms. If the digital channel is currently turned off, it will be denoted by "\*".

For the introductions of BX-AX,  $|dX|$  and  $1/|dX|$ , refer to the introductions in "**When the measurement source is set to CH1-CH4 or MATH**".

If needed, please refer to the following steps to modify the parameters of manual cursor measurement.

### 1. Select Cursor Type

Press **Select** to select "█" or "█".

- █: the X cursors are a pair of vertical solid (cursor A)/dotted (cursor B) lines and are usually used to measure time parameters.
- █: the Y cursors are a pair of horizontal solid (cursor A)/dotted (cursor B) lines and are usually used to measure voltage parameters.



**Note:** When the current measurement source is LA, the cursor type is "█" and cannot be set.

### 2. Select Measurement Source

Press **Source** to select the waveform of the analog channels (CH1-CH4), math operation results (MATH) or LA waveform for measurement.

**Note:** Only channel currently enabled can be selected.

### 3. Adjust Cursor Position

- Adjust cursorA: press **CursorA** and use  to adjust the position of cursorA. The measurement result will change accordingly during the adjustment and the adjustable range is limited within the screen.
- Adjust cursorB: press **CursorB** and use  to adjust the position of cursorB. The measurement result will change accordingly during the adjustment and the adjustable range is limited within the screen.
- Adjust cursorA and cursorB at the same time: press **CursorAB** and use  to adjust the positions of cursorA and cursorB at the same time. The measurement result will change accordingly during the adjustment and the adjustable range is limited within the screen.

**Note:** You can also press down  knob continuously to switch the current cursor.

### 4. Select X (Y) Axis Unit

Press **Units** to set the horizontal unit and vertical unit of the cursor measurement.

Press **Hori.Unit** to select "s", "Hz", "Degree" or "Percent".

- **s:** when this unit is selected, in the measurement results, AX, BX and BX-AX are in "s" and  $1/|dX|$  is in "Hz".
- **Hz:** when this unit is selected, in the measurement results, AX, BX and  $|dX|$  are in "Hz" and  $1/|dX|$  is in "s".
- **Degree:** when this unit is selected, in the measurement results, AX, BX and BX-AX are in "°". At this point, AX, BX and BX-AX will change to "0°", "360°" and "360°" respectively when you press **Set Range**, no matter where cursors A and B are currently located. At the same time, the two cursor lines (unmovable) appear on the screen as the reference positions.
- **Percent:** when this unit is selected, in the measurement results, AX, BX and BX-AX are in "%". At this point, AX, BX and BX-AX will change to "0%", "100%" and "100%" respectively when you press **Set Range**, no matter where cursors A and B are currently located. At the same time, the two cursor lines (unmovable) appear on the screen as the reference positions.

Press **Vert. Unit** to select "Source" or "Percent".

- **Source:** when this unit is selected, in the measurement results, the units of AY, BY and BY-AY will be automatically set to the unit of the current source.
- **Percent:** when this unit is selected, in the measurement results, AY, BY and BY-AY are in "%". At this point, AY, BY and BY-AY will change to "0%", "100%" and "100%" respectively when you press **Set Range**, no matter where cursors A and B are currently located. At the same time, the two cursor lines (unmovable) appear on the screen as the reference positions.

### 5. Select Screen Region

- When delayed sweep is enabled (pressing the **HORIZONTAL**  **SCALE** can enable Zoom), the screen is divided into two regions, Main and Zoom. Press **Cursor** → **Region** to select "Main" or "Zoom" and measure the



corresponding value. When "Main" is selected, the cursor values are displayed in the zoom region. When "Zoom" is selected, the cursor values are displayed in the main region.

**Note:**

- When the cursor measurement source is set to "LA" and the main time base is measured (namely the "Main" region is selected), there is not any Y axis measurement value.
- When the cursor measurement source is set to "MATH", you can only measure the zoom region using the cursor. At this point, "Zoom" is automatically selected and **Region** is grayed out.
- When the XY time base mode is selected, the measurement values of the manual cursor are displayed on the lower-half screen.

## 6. Measurement Example

Use manual cursor measurement to measure the period (BX-AX=1 ms) of a square waveform and the result is equal to the period from auto measurement, as shown in the figure below.

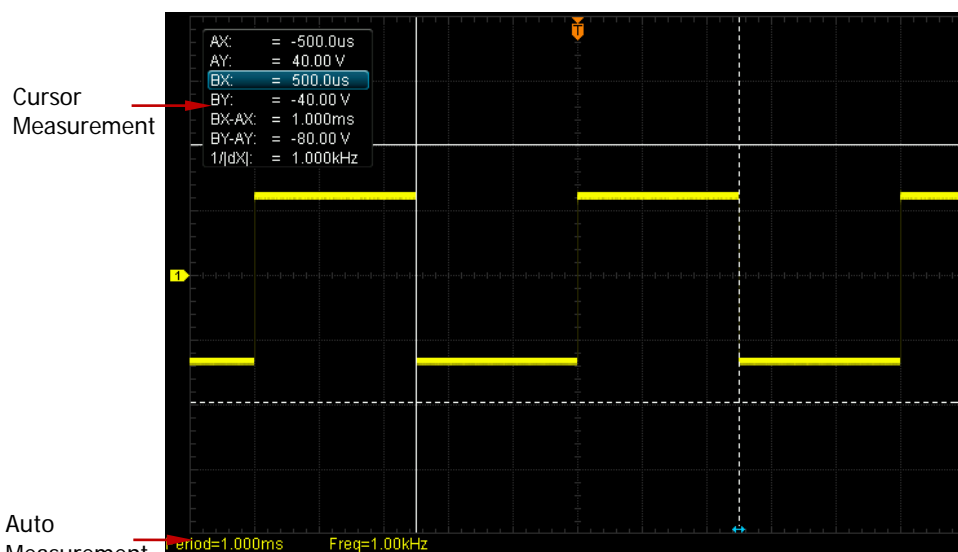



Figure 6-6 Manual Cursor Measurement Example

## Track Mode

In this mode, one or two pairs of cursors will appear. You can adjust the two pairs of cursors (cursor A and cursor B) to measure the X and Y values on two different sources respectively. The points being measured on cursors A and B are marked by  and  respectively. When the cursors are moved horizontally, the marks will position on the waveform automatically. When the waveform is expanded or compressed horizontally, the marks will track the points being marked at the last adjustment of the cursors.

Press **Cursor** → **Mode** → "Track" to turn on the cursor track function and the measurement results will be displayed at the upper left corner of the screen in the following mode.

```

AX:   = 552.0us
AY:   = -4.800 V
BX:   = -88.00us
BY:   = -12.80 V
BX-AX: = -640.0us
BY-AY: = -8.000 V
1/|dX|: = 1.562kHz
  
```

- AX: the X value at cursor A. The X value takes the trigger position as reference and "s" or "Hz" (when measuring FFT waveform) as its unit.
- AY: the Y value at cursor A. The Y value takes the channel GND as reference and use the same unit as the current source.
- BX: the X value at cursor B. The X value takes the trigger position as reference and "s" or "Hz" (when measuring FFT waveform) as its unit.
- BY: the Y value at cursor B. The Y value takes the channel GND as reference and use the same unit as the current source.
- BX-AX: the horizontal difference between cursors A and B.
- BY-AY: the vertical difference between cursors A and B.
- $1/|dX|$ : the reciprocal of the horizontal difference between cursors A and B.



If needed, please refer to the following steps to modify the track cursor measurement parameters.

### 1. Select Measurement Source

Press **CursorA** to select the waveform of analog channels (CH1-CH4) or math operation results (MATH) as the measurement source of cursor A (only channels enabled are available). You can also select "None", namely do not use cursor A. Press **CursorB** to select the waveform of analog channels (CH1-CH4) or math operation results (MATH) as the measurement source of cursor B (only channels enabled are available). You can also select "None", namely do not use cursor B.

### 2. Adjust Cursor Position

- Adjust cursor A: press **CursorA** and use  to adjust the position of cursor

- A. During the adjustment, the measurement result will change accordingly. The adjustable range is limited within the screen.
- Adjust cursor B: press **CursorB** and use  to adjust the position of cursor B. During the adjustment, the measurement result will change accordingly. The adjustable range is limited within the screen.
  - Adjust cursor A and B at the same time: press **CursorAB** and use  to adjust the position of cursor A and B at the same time. During the adjustment, the measurement results will change accordingly. The adjustable range is limited within the screen.

**Note:**

- Under the current menu, you can rotate  to switch the current cursor.
- In track mode, the cursor will track the marked point (namely jumps up and down with the transient change of the waveform). Thus, the Y value might change even though you do not adjust the cursor.

## Auto Mode

In this mode, one or more cursors will appear. You can use auto cursor measurement to measure any of the 37 waveform parameters. Before using this mode, you need to at least enable one auto measurement parameter and the number of cursors will change with the measurement parameter enabled.

Press **Cursor** → **Mode** → "Auto" and the number of cursors displayed on the screen is determined by the measurement parameter enabled (different measurement parameter needs different number of cursors).

**Note:** No cursor will be displayed if no auto cursor measurement parameter is enabled or the measurement source has no input. When the waveform is expanded or compressed horizontally, the cursor will move accordingly.

You can press the parameter measurement softkeys at the left of the screen to directly switch the waveform parameter currently measured by auto cursors. If multiple measurement parameters are turned on later, you can use **Auto Item** to switch among at most five measurement parameters that are turned on last. If "NONE" is selected, cursor measurement will not be used.

The following figure shows the auto measurement example of sine signal frequency in CH2.



Figure 6-7 Auto Cursor Measurement

## XY Mode

XY mode is only available when the horizontal time base mode is "XY". In this mode, two pairs of cursors will appear. You can adjust the cursor positions and the instrument will automatically calculate the chord length and curvature of the ellipses corresponding to the crossing points of the two pairs of cursor lines.

Press **Cursor** → **Mode** → "XY" to enable the XY mode cursor measurement function. The measurement results are displayed at the upper left corner of the screen in the following mode.

AX:	=	4.080 V
AY:	=	4.000 V
BX:	=	-4.000 V
BY:	=	-4.000 V
BX-AX:	=	-8.080 V
BY-AY:	=	-8.000 V
dX*dY:	=	64.64
dX/dY:	=	1.010
dY/dX:	=	990.1m
absAA:	=	5.714
absAB:	=	5.714
absBA:	=	5.657
absBB:	=	5.657
argAA:	=	44.43 °
argAB:	=	-44.43 °
argBA:	=	135.0 °
argBB:	=	-135.0 °

- AX: the X value at cursor AX.
- AY: the Y value at cursor AY.
- BX: the X value at cursor BX.
- BY: the Y value at cursor BY.
- BX-AX: the horizontal difference between cursors BX and AX.
- BY-AY: the vertical difference between cursors BY and AY.
- dX\*dY: the product of the horizontal difference between cursors BX and AX times the vertical difference between cursors BY and AY.
- dX/dY: the quotient of the horizontal difference between cursors BX and AX divided by the vertical difference between cursors BY and AY.
- absAA: the chord length of the crossing point of cursors AX and AY relative to the center point. The center point is defined as the crossing point of the horizontal position

(X-axis) and the vertical position (Y-axis) of two channel labels on the screen as shown in Figure 6-8.

- absAB: the chord length of the crossing point of cursors AX and BY relative to the center point.
- absBA: the chord length of the crossing point of cursors BX and AY relative to the center point.
- absBB: the chord length of the crossing point of cursors BX and BY relative to the center point.
- argAA: the angle between X-axis and absAA. The range is from -180° to +180°.
- argAB: the angle between X-axis and absAB. The range is from -180° to +180°.
- argBA: the angle between X-axis and absBA. The range is from -180° to +180°.
- argBB: the angle between X-axis and absBB. The range is from -180° to +180°.

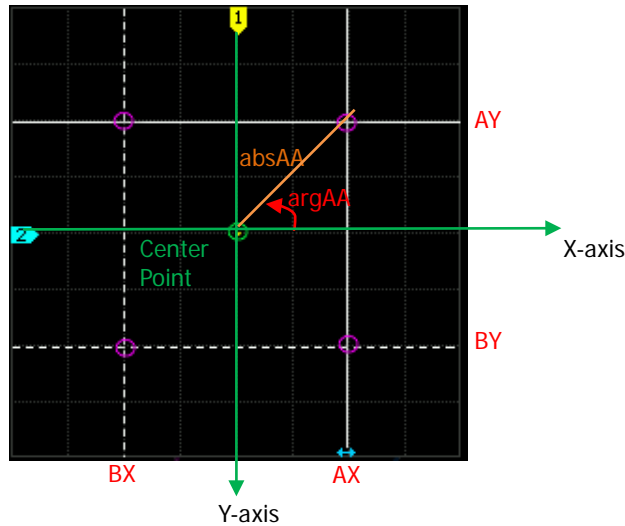

Figure 6-8 XY Cursor Measurement Definition

1. Select Values

Press **Values** and use to turn the value(s) to be measured on or off. The measurement items opened are displayed at the upper left corner of the screen.



- $\Delta X, \Delta Y$ : Open the BX-AX and BY-AY measurement items.
- $\Delta X * \Delta Y$ : Open the  $dX * dY$  measurement item.
- $\Delta X / \Delta Y$ : Open the  $dX / dY$  measurement item.
- $\Delta Y / \Delta X$ : Open the  $dY / dX$  measurement item.
- AX,AY: Open the absAA and argAA measurement items at the same time.
- AX,BY: Open the absAB and argAB measurement items at the same time.
- BX,AY: Open the absBA and argBA measurement items at the same time.
- BX,BY: Open the absBB and argBB measurement items at the same time.

2. Adjust Cursor Position

- Adjust cursor AX: press **AX** and use to adjust the position of cursor AX.
- Adjust cursor BX: press **BX** and use to adjust the position of cursor BX.
- Adjust cursor AY: press **AY** and use to adjust the position of cursor AY.
- Adjust cursor BY: press **BY** and use to adjust the position of cursor BY.
- Adjust cursors AX and BX at the same time: press **ABX** and use to adjust the position of cursors AX and BX at the same time.
- Adjust cursors AY and BY at the same time: press **ABY** and use to adjust the position of cursors AY and BY at the same time. During the adjustment, the measurement results will change accordingly. The adjustable range is limited within the screen.

**Note:** You can also press down  knob continuously to switch the current cursor.

### 3. Display Lissajous Legend

This oscilloscope provides the lissajous schematic diagram under different frequencies and phases.

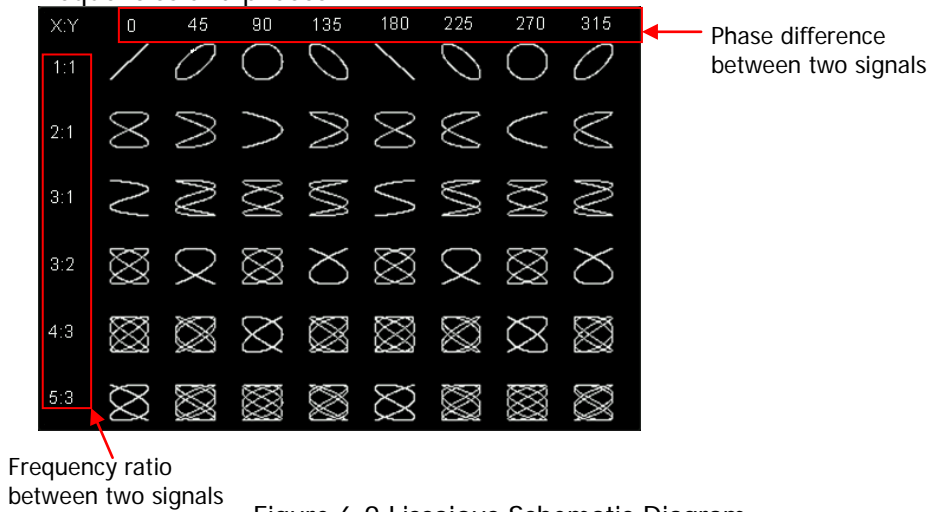

Figure 6-9 Lissajous Schematic Diagram





## Chapter 7 Digital Channel

MSO1000Z provides 4 analog channels as well as 16 digital channels. DS1000Z Plus can be upgraded to MSO using the MSO upgrade option. For the digital channels, the oscilloscope compares the voltages acquired in each sample with the preset logic threshold. If the voltage of the sample point is greater than the logic threshold, it will be stored as logic 1; otherwise, it will be stored as logic 0. The oscilloscope displays the logic 1 and logic 0 in figure form for users to easily detect and analyze the errors in circuit design (hardware design and software design). This chapter introduces how to use the digital channels of the mixed signal digital oscilloscopes.



Before using the digital channels, connect the oscilloscope and the device under test using RPL1116 logic probe provided in the accessories. For the using method of the logic probe, refer to the *RPL1116 Logic Probe User's Guide*.

**Note:** The digital channel input terminal does not support hot plug. Please do not insert or pull out the logic probe when the instrument is powered on.

The contents of this chapter:

- To Select the Digital Channel
- To Turn on/off the Digital Channel
- Group Set
- To Set the Waveform Display Size
- Reorder Setting
- Auto View
- To Set the Threshold
- To Set the Label
- Probe Calibration
- Digital Channel Delay Calibration

## To Select the Digital Channel

Press **LA** to open the logic analysis control menu. You can select any of the digital channels or user-defined digital channel groups. Press **Current** to open the channel/group dropdown menu and rotate the multifunction knob  to select the desired channel or channel group. You can also press **Current** or **VERTICAL**  **POSITION** continuously to switch among the options in order.

- D0-D15: select any channel of D0-D15. The channel label and waveform corresponding to the channel selected are displayed in red.
- Group1-Group4: select any of the user-defined groups (Group1-Group4). The channel labels and waveforms of all the channels of the channel group selected are displayed in red.
- None: do not select any channel/group.

**Note:** Only digital channels or user-defined groups that are turned on can be selected.

For how to turn on the digital channel/group, please refer to the introduction in "**To Turn on/off the Digital Channel**".

For how to define channel group, please refer to the introduction in "**Group Set**".

## To Turn on/off the Digital Channel

You can turn on or off the digital channels through the following two methods.









### Method One:

Press **D7-D0** to turn on or off channels D7-D0 at the same time.

Press **D15-D8** to turn on or off channels D15-D8 at the same time.

### Method Two:

Press **ON/OFF** to enter the digital channel/group "ON/OFF" setting menu.

- Press **SelectCH** to turn on channels D0-D15 selection list. Rotate  to select any channel and press  to turn on or off the channel. You can also press **SelectCH** continuously to turn on or off the selected channel. Channels turned on are marked with  and channels that are not turned on are marked with . You can turn on or off any channel via the channel selection menu.
- Press **Group**, rotate  to select any channel group and press down  to turn on or off all the channels in the group at the same time. You can also press **Group** continuously to turn on or off the selected group. The channel groups turned on are marked with  and the channel groups that are not turned on are marked with .

### Note:

- When you have turned off channels D7-D0 at the same time using **D7-D0**, you can still turn on or off any of the channels via the channel selection

menu. When you have turned on channels D7-D0 at the same time using **D7-D0**, the channels in the list switch to ON status automatically. The situation of channels D15-D8 is similar.

- Only user-defined digital channel groups can be selected.





For how to define channel groups, please refer to the introduction in "**Group Set**".

## Group Set

Press **Group Set** to enter the user-defined group setting menu. You can perform group and ungroup operations on the 16 digital channels.



- **Group:**

The group operations of Group1-Group4 are the same and Group1 is taken as an example for illustration.

Press **Group1** to turn on channels D0-D15 selection list (the status label is located at the left side of each channel), rotate  to select the channel to be added into Group1 and press down  or **Group1** to add the channel selected to Group1. Channels added into Group1 are marked with  and channels that are not added into Group1 is marked with .

Use the same method to group the other channels. Each channel can only be added into a single group and channels that are already added into other group cannot be selected (its status label  is gray). You can group the 16 digital channels (D0-D15) via the group setting.

- **Ungroup:**

Press **UnGroup** to open the channel/group list and rotate  to select the desired channel/group. If any of channels D0-D15 is selected, pressing down  will cancel the group operation of the channel; if any of Group1-Group4 is selected, pressing down  will cancel the group operations of all the channels in the group.

**Note:**

- You can only perform the ungroup operation on the grouped digital channels or digital channel groups.
- If none group is set, **UnGroup** will be grayed out and disabled.

## To Set the Waveform Display Size

Press **WaveSize** to open the waveform size selection list. You can use  or press **WaveSize** to set the waveform display size of the channel currently turned on to S (small) and L (large).

**Note:**

- L (large) can only be used when the number of channels currently turned on is no more than 8.
- You can also directly rotate **VERTICAL**  **SCALE** to set the waveform display size. Turn clockwise to set it to L; turn counterclockwise to set it to S.

## Reorder Setting

Press **ReOrder** to select the waveform order mode on the screen of the channels currently selected. You can select "D0-D15" or "D15-D0" and the default is "D0-D15".

- D0-D15: the waveforms on the screen are D0-D15 from top to bottom.
- D15-D0: the waveforms on the screen are D15-D0 from top to bottom.

## Auto View

Press **Auto View** and the analog channel waveform and digital channel waveform will be displayed respectively on the upper and lower half screen respectively. By default, the digital channel waveforms are displayed on the upper half screen and the analog channel waveforms are displayed on the lower half screen.

**Note:** When the number of channels currently turned on is more than 8 or the waveform display size is L, **Auto View** is grayed out and disabled.

## To Set the Threshold

Press **Threshold** to enter the threshold setting menu. When the voltage of the input signal is greater than the threshold currently set, it is treated as logic 1; otherwise, it is treated as logic 0.

The threshold levels of channels D7-D0 and channels D15-D8 can be set separately according to the need. You can select a preset value or user-defined threshold. The range of the user-defined threshold is from -15.0 V to +15.0 V.

Press **Low Type** to open the threshold selection list to select the threshold of D7-D0. The selectable preset values include TTL (1.40 V), CMOS (2.50 V), ECL (-1.30 V), PECL (3.70 V), LVDS (1.20 V) and 0V. You can also press **D7-D0** and use  to set

the desired threshold.

Press **High Type** to open the threshold selection list to select the threshold of D15-D8. The selectable preset values include TTL (1.40 V), CMOS (2.50 V), ECL (-1.30 V), PECL (3.70 V), LVDS (1.20 V) and 0V. You can also press **D15-D8** and use  to set the desired threshold.

## To Set the Label

You can set another label for each digital channel using the following two methods to easily distinguish the digital channels.

- **Use preset labels**  
Press **Select CH** to select the digital channel (any channel of D0-D15) that needs to set a label. Press **Preset** to select ACK, AD0, ADDR, BIT, CAS, CLK, CS, DATA, HALT, IN, INT, LOAD, MISO, MOSI, NMI, OUT, PAS, PIN, RDY, RST, RX, TX or WR.
- **Input a label manually**  
Press **Label Edit** to enter the label input interface to input a label manually. For the input method, refer to the introduction in "**Channel Label**".

Press **Clear** to delete the label of the current channel.

## Probe Calibration

You can calibrate the digital probe via the oscilloscope to reduce the measurement error of the digital signal. Connect RPL1116 digital probe to the oscilloscope and make sure that no signal is connected to the digital probe. Press **Probe-Cal** → **Start** to start calibrating the zero point of the digital probe. Press **Exit** to exit the calibration.

**Note:** Before calibrating the probe, please make sure that there is no signal input into the connected digital probe.

## Digital Channel Delay Calibration

When using the oscilloscope for actual measurement, the transmission delay of the probe cable may cause relatively larger error (zero offset). Zero offset is defined as the offset of the crossing point of the waveform and threshold level line relative to the trigger position. You can set a delay time to calibrate the zero offset of the digital channels.

Press **Delay-Cal** and rotate  to set the delay calibration time. The range is from -100 ns to 100 ns.

**Note:** The delay calibration setting is related to the instrument model and the current horizontal time base. The larger the horizontal time base is, the larger the setting step will be. Take MSO1104Z as an example; the steps under different horizontal time bases are as shown in the table below.

Table 7-1 Relationship between the delay calibration step and horizontal time base

Horizontal Time Base	Delay Calibration Time Step
5 ns	100 ps
10 ns	200 ps
20 ns	400 ps
50 ns	1 ns
100 ns	2 ns
200 ns	4 ns
500 ns	10 ns
1 $\mu$ s to 10 $\mu$ s	20 ns

**Note:** When the horizontal time base is equal to or greater than 10  $\mu$ s, the delay calibration time cannot be adjusted.

## Chapter 8 Protocol Decoding

Protocol analysis can be used by users to discover errors, debug hardware and accelerate development easily, so as to guarantee quick and high-quality accomplishment of projects. Protocol decoding is the basis of protocol analysis. Only protocol analyses with correct protocol decoding are acceptable and only correct protocol decoding can provide more error information. MSO1000Z/DS1000Z provides two bus decoding modules (Decode 1 and Decode 2) to make common protocol decoding (including Parallel (standard), RS232 (optional), I2C (optional) and SPI (optional)) for the input signals of the analog channels (CH1-CH4) and digital channels (D0-D15). Among these decoding types, RS232 decoding, I2C decoding, and SPI decoding are serial bus decodings. As the decoding functions and setting methods of Decode 1 and Decode 2 are the same, this chapter only takes Decode1 for illustration.

To get the decoding option information, please refer to the introduction in "**Appendix A: Accessories and Options**". When you have ordered the decoding option, please refer to the introduction in "**Option Management**" to activate corresponding option.

The contents of this chapter:

- Parallel Decoding
- RS232 Decoding (Optional)
- I2C Decoding (Optional)
- SPI Decoding (Optional)

## Parallel Decoding

Parallel bus consists of clock line and data line. As shown in the figure below, CLK is the clock line, while Bit0 and Bit1 are the 0 bit and 1st bit on the data line respectively. The oscilloscope will sample the channel data on the rising edge, falling edge or the rising/falling edge of the clock and judge each data point (logic "1" or logic "0") according to the preset threshold level.

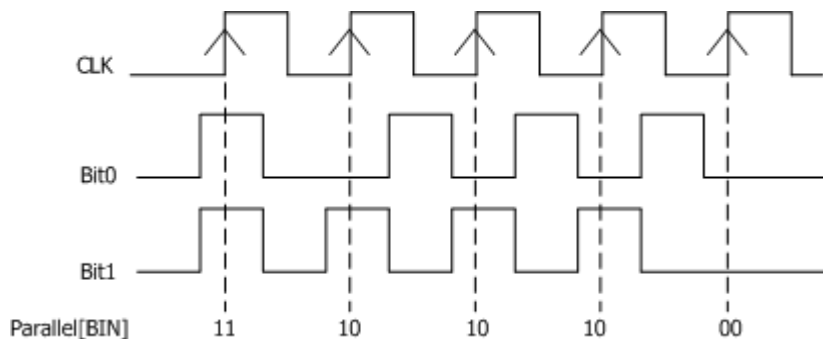





Figure 8-1 Parallel Decoding

Press **MATH** → **Decode1** → **Decoder** to select "Parallel" and open the parallel decoding function menu.

1. Press **Decode** to turn on or off the decoding function.
2. **Clock Line Setting (CLK)**
  - Press **CLK** to select any channel (CH1-CH4 or D0-D15) as the clock channel. If "OFF" is selected, no clock channel is set.
  - Press **Edge** to set the oscilloscope to sample the channel data on the rising edge () , falling edge () or rising/falling edge () of the clock. If no clock channel is selected, the instrument will sample when the channel data jumps during the decoding.
3. **Digital Bus**  
Press **BUS** to select the digital bus for parallel decoding. This setting will automatically modify the settings of **Width**, **Bit X** and **CH**, as shown in the table on the next page.



BUS	Width	BitX	CH	Note
D7-D0	8	0	D0	Bit0 to Bit7 are set to D0 to D7 respectively.
D15-D8	8	0	D8	Bit0 to Bit7 are set to D8 to D15 respectively.
D15-D0	16	0	D0	Bit0 to Bit15 are set to D0 to D15 respectively.
D0-D7	8	0	D7	Bit0 to Bit7 are set to D7 to D0 respectively.
D8-D15	8	0	D15	Bit0 to Bit7 are set to D15 to D8 respectively.
D0-D15	16	0	D15	Bit0 to Bit15 are set to D15 to D0 respectively.

In addition, you can also modify the settings of **Width**, **Bit X** and **CH** manually.

**Note:** This function is only applicable to MSO1000Z and DS1000Z Plus with the MSO upgrade option.

#### 4. Data Line Setting

- **Set the bus width**

Press **Width** to set the data width of the parallel bus namely the number of bits per frame. The default is 8 and the range is from 1 to 16.

- **Specify data channel for each bit.**

Press **Bit X** to select the bit that needs to specify a channel. Press **CH** to specify a channel source from CH1-CH4 or D0-D15.

#### 5. Analog Channel Threshold Setting

To judge logic "1" and logic "0" of the buses, you need to set a threshold for each analog channel (CH1-CH4). When the signal amplitude is greater than the preset value, it is considered as "1"; otherwise "0".

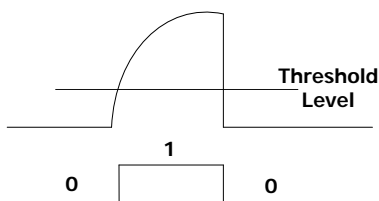

Press **MATH** → **Decode Options** → **Auto Thre.** to turn on or off the auto threshold function. When auto threshold is turned on, the middle value of the channel waveform is defined as the digital threshold level. When auto threshold is turned off, you can press **Thre.Set** to enter the threshold setting menu. Press **CH1**, **CH2**, **CH3** and **CH4** respectively and use  to set the threshold of each channel. Press **50%** and set the current threshold to 50% of the current waveform trace manually.

## 6. Display-related Setting

- Press **Format** to set the display format of the bus to HEX, DEC, BIN, ASC or LINE.  
**Note:** In LINE format, the actual values of the bus are displayed in binary form and the order is consistent with the bus transmission order. This format is only valid for the serial bus which includes LSB and MSB endian. If MSB endian is selected, LINE format is the same as binary.
- Press **Pos** and use  to adjust the vertical display position of the bus.

### Tip

Press **MATH** → **Decode Options** → **ASC List**, characters, numbers and ASCII table of the common control characters will be displayed on the screen. You can instantly query the corresponding ASCII value.

## 7. Noise Rejection

Press **NRJ** to enable or disable the noise rejection function. Noise rejection can remove the data without enough duration on the bus to eliminate the burst glitch of the actual circuit. When the noise rejection is enabled, press **NRJ.Time** to set the desired rejection time and the range is from 0.00 s to 100 ms.

## 8. Clock Compensation

Press **CLK Tune** to set the compensation time. You can fine-tune the phase difference between the clock line and data line. The setting range is from -100 ms to 100 ms. A negative value indicates the clock moves forward and a positive value indicates the clock moves backward.

## 9. Curve

Press **Plot** to enable or disable the curve function. When "ON" is selected, the change trend of the bus data will be displayed in vector mode.

## 10. Polarity

Press **Polarity** to select the data polarity.

## 11. Decoding Configuration

Press **Configure** to enter the decoding configuration submenu.

- Press **Label** to enable or disable the label display function. When "ON" is selected, the bus label will be displayed at the upper left of the bus (the bus display is turned on).
- Press **Line** to enable or disable the bus display function. When "ON" is selected, the bus will be displayed on the screen. You can use "**Pos**" to adjust the vertical display position of the bus.
- Press **Format** to enable or disable the format display function. When "ON" is selected, the current bus display format will be displayed on the right side of the label display (the bus display is turned on). You can use "**Format**" to set the display format of the bus.

- Press **Width** to enable or disable the width display function. When "ON" is selected, the current bus width will be displayed on the right side of the format display (the bus display is turned on). You can use "**Width**" to set the bus width.
- **Dig.Sa** menu displays the current digital sample rate which relates to the data source selected currently. When the data source is "Trace", the digital sample rate relates to the horizontal time base.

**Note:** By default, MSO1000Z/DS1000Z uses "Trace" as the data source.

## 12. Event Table

The event table displays the decoded data and the corresponding line number and time in table format. It can be used to observe relatively longer decoded data. Press **Evt.Table** → **EventTable** to select "ON" (**Note:** This operation is only available when **MATH** → **Decode1** / **Decode2** → **Decode** is set to "ON") to enter the event table interface as shown in Figure 8-2.

**Format:** set "Data" display format in the event table to HEX, DEC or ASC.

**Focus:** press this key and turn  to browse the "Data" item.

**View:** select the display form of the event table. If "Packets" is selected, the time and data are displayed in the event table; if "Details" is selected, the detailed data of the specified row will be displayed in the event table; if "Payload" is selected, all data of the specified column will be displayed in the event table. When different view is selected, the export format of the data table will change accordingly.

**Data:** select the data column to be viewed in the "Details" or "Payload" view. It is valid for the decoder of multiple data output.

**Order:** select the display type of decoding result in the event table to "Ascend" or "Descend".

**Export:** if a USB storage device (FAT32 format, flash memory) is currently connected to the instrument, press this softkey to export the data table to the external USB storage device in CSV format ("Packets" is selected) or HEX format ("Payload" or "Details" is selected).

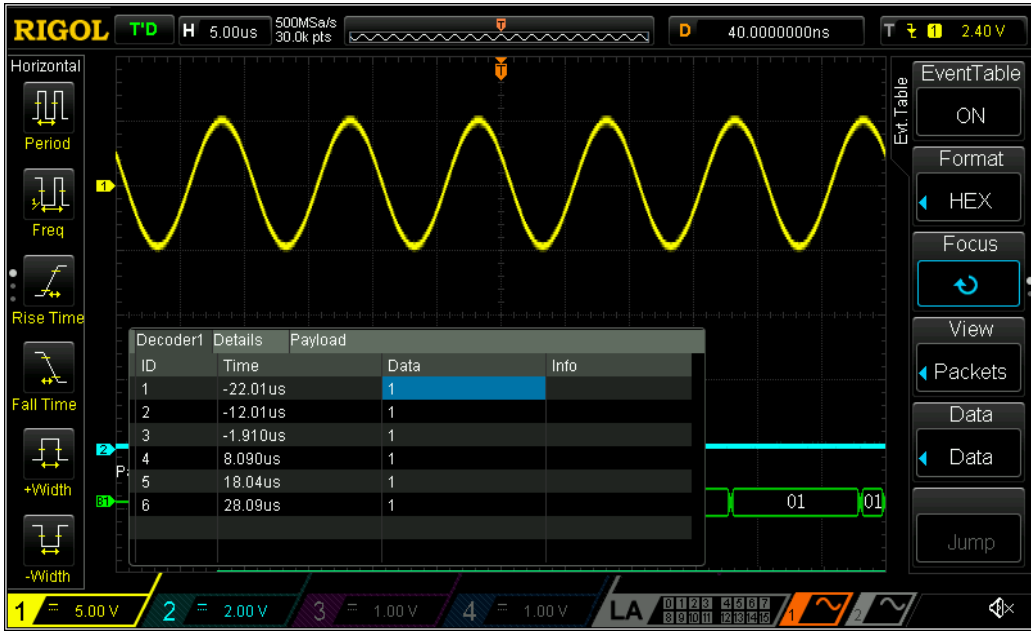

Figure 8-2 Parallel Decoding Event Table

## RS232 Decoding (Optional)

RS232 serial bus consists of the transmitting data line (TX) and the receiving data line (RX).

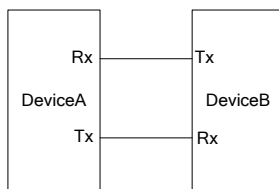

Figure 8-3 RS232 Serial Bus Schematic Diagram

The industry standard of RS232 uses "Negative Logic", namely high level is logic "0" and low level is logic "1".

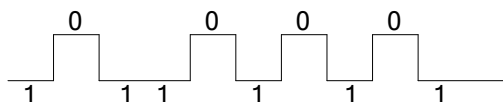
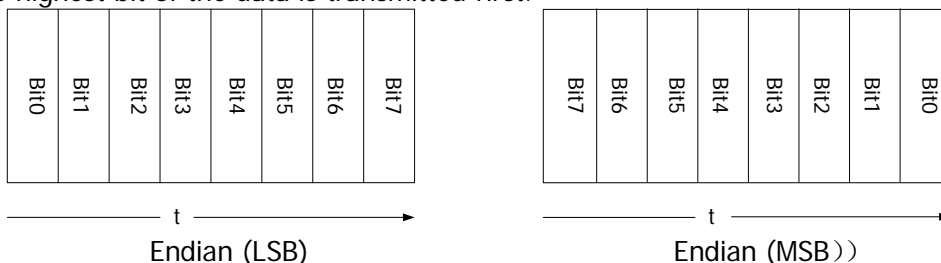

Figure 8-4 Negative Logic Schematic Diagram

By default, RS232 uses LSB (Least Significant Bit) transmission sequence, namely the lowest bit of the data is transmitted first. While for MSB (Most Significant Bit), the highest bit of the data is transmitted first.



In RS232, baud rate is used to represent the transmitting rate (namely bits per second) of the data. The commonly used baud rates include 2400 bps, 4800 bps, 9600 bps, 19200 bps, 38400 bps, 57600 bps and 115200 bps.

In RS232, you need to set the start bit, data bits, check bit (optional) and stop bit of each frame of data.

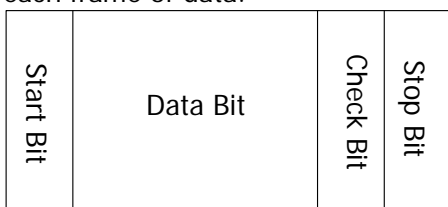

**Start Bit:** represent when the data starts outputting.



**Data Bits:** represent the number of data bits actually contained in each frame of data.

**Check Bit:** used to check the correctness of the data transmission.

- **Odd Checkout:** the total number of "1" in the data bit and check bit is an odd. For example, when 0x55 (01010101) is sent, a 1 needs to be filled in the check bit to make the number of 1 be an odd.
- **Even Checkout:** the total number of "1" in the data bit and check bit is an even. For example, when 0x55 (01010101) is sent, a 0 should be filled in the check bit.
- **None:** there would not be check bit during the transmission.

**Stop Bit:** represent when the data stops outputting.

Press **MATH** → **Decode1** → **Decoder** to select "RS232" to open the RS232 decoding function menu.

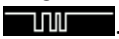
1. Press **Decode** to turn on or off the decoding function.
2. **TX and RX Channel Setting**  
Press **Tx** to select any channel (CH1-CH4 or D0-D15) as the transmitting channel and when "OFF" is selected, no transmitting channel is set. Use the same method the set the **Rx** channel.
3. **Baud Rate Setting**  
Press **Baud** and use  to set the desired baud rate. The range is from 110 to 20000000. You can also press **Preset** to select 2400, 4800, 9600, 19200, 38400, 57600, 115200, 230400, 460800, 9216000, 1M, 2M, 5M, 10M and 20M. The default is 9600 and the unit is bps.
4. **Copy Trigger**  
Press **CopyTrig** to copy the protocol trigger settings from the trigger system and set the corresponding decoding parameters automatically. During RS232 decoding, this function is valid only when the trigger type is RS232 trigger. You can copy the settings of data channel, width, baud rate, stop bit, check mode and polarity.
5. **Polarity Setting**  
Press **Polarity** to select " (positive)" or " (negative)" and the default is .
6. **Order Setting**  
Press **Order** to select "LSB" or "MSB" and the default is "LSB".
7. **Data Line Setting**  
As mentioned before, in RS232, you need to set the start bit, data bits, check bit (optional) and stop bit of each frame of data. "Start Bit" is specified by the

"Polarity Setting". The setting methods of other parameters are as follows.

- Press **Data** to set the data width of each frame. It can be set to 5, 6, 7 or 8 and the default is 8.
- Press **Stop** to set the stop bit after each frame of data. It can be set to 1 bit, 1.5 bits or 2 bits.
- Press **Parity** to set the even-odd check mode of the data transmission. It can be set to None, Odd or Even.

## 8. Analog Channel Threshold Setting

For more details, please refer to the introduction in "**Analog Channel Threshold Setting**" of parallel decoding.

## 9. Display-related Setting

For more details, please refer to the introduction in "**Display-related Setting**" of parallel decoding.

## 10. Event Table

Press **Evt.Table** → **EventTable** to select "ON" (**Note:** This operation is only available when **MATH** → **Decode1** / **Decode2** → **Decode** is set to "ON") to enter the event table interface.

**Format:** set "Data" display format in the event table to HEX, DEC or ASC.

**Focus:** press this key and turn  to browse the "Data" item.

**View:** select the display form of the event table. If "Packets" is selected, the time and data are displayed in the event table; if "Details" is selected, the detailed data of the specified row will be displayed in the event table; if "Payload" is selected, all data of the specified column will be displayed in the event table. When different view is selected, the export format of the data table will change accordingly.

**Data:** select the data column to be viewed in the "Details" or "Payload" view. During RS232 decoding, if TX and RX channels are set at the same time, you can specify to display TX or RX data.

**Order:** select the display type of decoding result in the event table to "Ascend" or "Descend".

**Export:** if a USB storage device (FAT32 format, flash memory) is currently connected to the instrument, press this softkey to export the data table to the external USB storage device in CSV format ("Packets" is selected) or HEX format ("Payload" or "Details" is selected).

## 11. Decoding Configuration

Press **Configure** to enter the decoding configuration submenu.

- Press **Label** to enable or disable the label display function. When "ON" is selected, the bus label will be displayed at the upper left of the bus (the bus display is turned on).

- Press **Line** to enable or disable the bus display function. When "ON" is selected, the bus will be displayed on the screen. You can use "**Pos**" to adjust the vertical display position of the bus.
- Press **Format** to enable or disable the format display function. When "ON" is selected, the current bus display format will be displayed on the right side of the label display (the bus display is turned on). You can use "**Format**" to set the display format of the bus.
- Press **Endian** to enable or disable the endian display function. When "ON" is selected, the current bus endian will be displayed on the right side of the format display (the bus display is turned on). You can use "**Order**" to set the bus endian.
- Press **Width** to enable or disable the width display function. When "ON" is selected, the width per frame data will be displayed on the right side of the endian display (the bus display is turned on). You can use "**Width**" to set the width per frame data.
- **Did.Sa** menu displays the current digital sample rate which relates to the data source selected currently. When the data source is "Trace", the digital sample rate relates to the horizontal time base.

**Note:** By default, MSO1000Z/DS1000Z uses "Trace" as the data source.

### 12. The Error Expression during Decoding

**End Frame Error:** errors generated when the end frame condition is not met. When the stop bit is set to 1, error mark "?" will be displayed if the stop bit is less than 1.

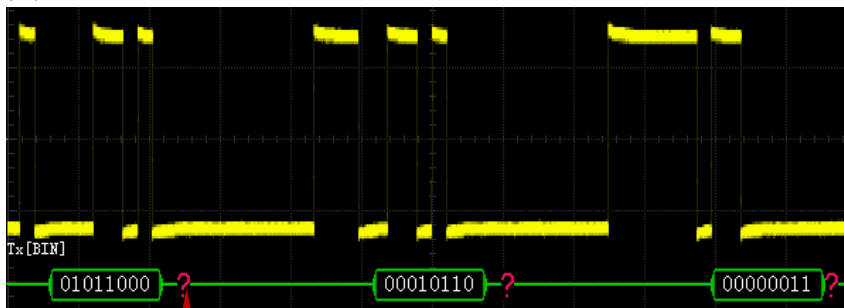

The stop bit is less than 1

**Check Error:** when check bit error is detected during the decoding, error mark "?" will be displayed. For example, when the transmitting terminal is set to none check and the decoder is set to odd check, the following check error occurs.



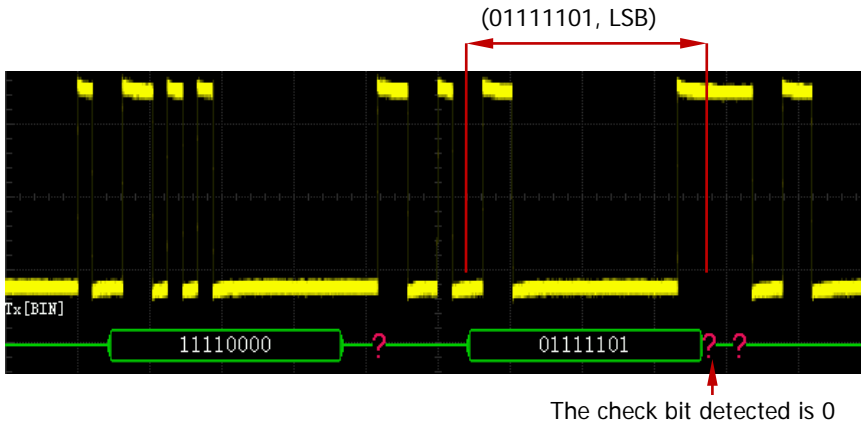

Wherein, there are even number of 1 in the 8-bit data 01111101 and the check bit should be 1; but the check bit detected on the TX is 0, thus check error occurs.

**Note:** Two error marks will be displayed when end frame error and check error are detected at the same time.

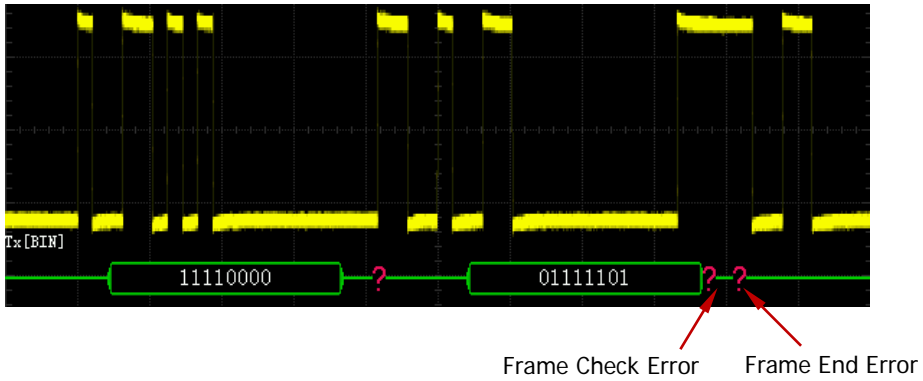

## I2C Decoding (Optional)

I2C serial bus consists of the clock line (SCLK) and the data line (SDA).

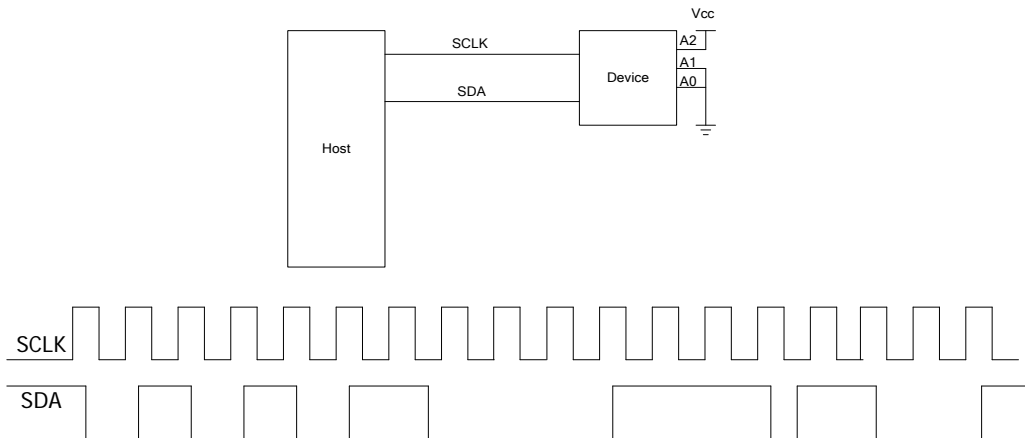

Figure 8-5 I2C Serial Bus

Press **MATH** → **Decode1** → **Decoder** to select "I2C" and open the I2C decoding function menu.

1. Press **Decode** to turn on or off the decoding function.
2. **CLK Setting**  
Press **CLK** to select any channel (CH1-CH4 or D0-D15) as the clock channel.
3. **SDA Setting**  
Press **DATA** to select any channel (CH1-CH4 or D0-D15) as the data channel.  
**Note:** Press **Exchange** to switch the current signal sources of the clock channel and data channel.
4. **Copy Trigger**  
Press **CopyTrig** to copy the protocol trigger settings from the trigger system and set the corresponding decoding parameters automatically. During I2C decoding, this function is valid only when the trigger type is I2C trigger. You can copy the settings of clock and data channels.
5. **Analog Channel Threshold Setting**  
For more details, please refer to the introduction in "**Analog Channel Threshold Setting**" of parallel decoding.
6. **Display-related Setting**  
For more details, please refer to the introduction in "**Display-related Setting**" of parallel decoding.

## 7. Event Table

The event table displays the decoded data, the corresponding line number and time in table format. Press **Evt. Table** → **EventTable** to select "ON" (**Note:** This operation is only available when **MATH** → **Decode1** / **Decode2** → **Decode** is set to "ON") to enter the event table interface.

**Format:** set "Data" display format in the event table to HEX, DEC or ASC.

**Focus:** press this key and turn  to browse the "Data" item.

**View:** select the display form of the event table. If "Packets" is selected, the time and data are displayed in the event table; if "Details" is selected, the detailed data of the specified row will be displayed in the event table; if "Payload" is selected, all data of the specified column will be displayed in the event table. When different view is selected, the export format of the data table will change accordingly.

**Data:** select the data column to be viewed in the "Details" or "Payload" view. It is valid for the decoder of multiple data output.

**Order:** select the display type of decoding result in the event table to "Ascend" or "Descend".

**Export:** if a USB storage device (FAT32 format, flash memory) is currently connected to the instrument, press this softkey to export the data table to the external USB storage device in CSV format ("Packets" is selected) or HEX format ("Payload" or "Details" is selected).

## 8. Decoding Configuration

Press **Configure** to enter the decoding configuration submenu.

- Press **Label** to enable or disable the label display function. When "ON" is selected, the bus label will be displayed at the upper left of the bus (the bus display is turned on).
- Press **Line** to enable or disable the bus display function. When "ON" is selected, the bus will be displayed on the screen. You can use **Pos** to adjust the vertical display position of the bus.
- Press **Format** to enable or disable the format display function. When "ON" is selected, the current bus display format will be displayed on the right side of the label display (the bus display is turned on). You can use **Format** to set the display format of the bus.
- Press **Endian** to enable or disable the endian display function. When "ON" is selected, the current bus endian will be displayed on the right side of the format display (the bus display is turned on). The default is MSB.
- Press **Width** to enable or disable the width display function. When "ON" is selected, the width per frame data will be displayed on the right side of the endian display (the bus display is turned on). The default is 8.
- **Dig.Sa** menu displays the current digital sample rate which relates to the data source selected currently. When the data source is "Trace", the digital

sample rate relates to the horizontal time base.

**Note:** By default, MSO1000Z/DS1000Z uses "Trace" as the data source.

### 9. Address Information during Decoding

In I2C bus, the front part of each frame of data contains the address information and blue patches are used to represent the address ID. In the ID, "Write" is used to represent writing address and "Read" is used to represent reading address.

Press **ADDR** to select "Normal" or "R/W". When "R/W" is selected, "**AddrBits**" will include the "R/W" bit as a part of the address value.

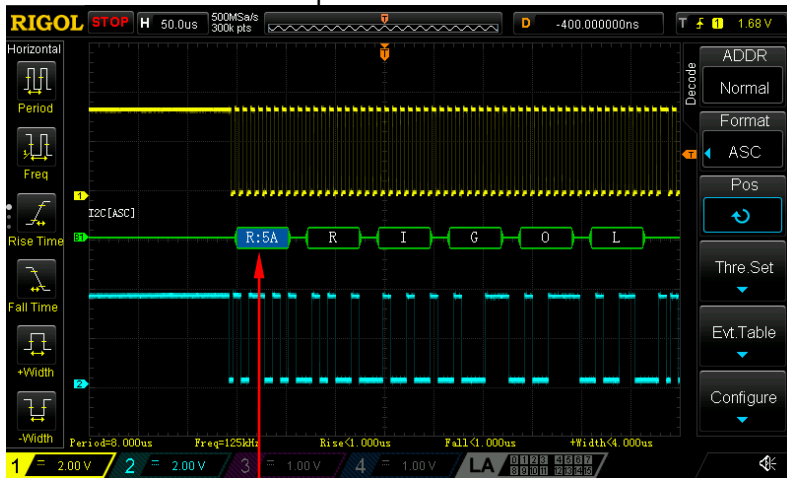

Address ID

Figure 8-6 I2C Address Information during Decoding

When the ACK (ACKnowledge Character) is not met, error marks "?" as shown in the figure below will be displayed.

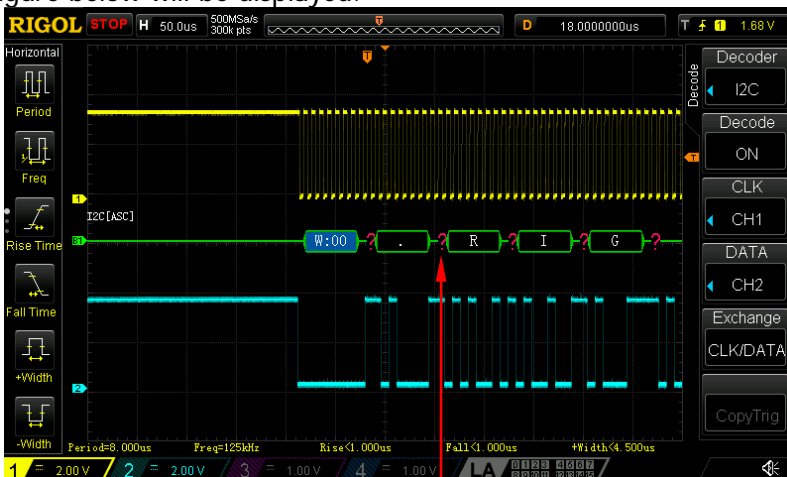

ACK=1

Figure 8-7 I2C Error Expressions during Decoding

## SPI Decoding (Optional)

SPI bus is based on the master-slave configuration and usually consists of chip select line (CS), clock line (SCLK) and data line (SDA). Wherein, the data line includes MISO and MOSI.

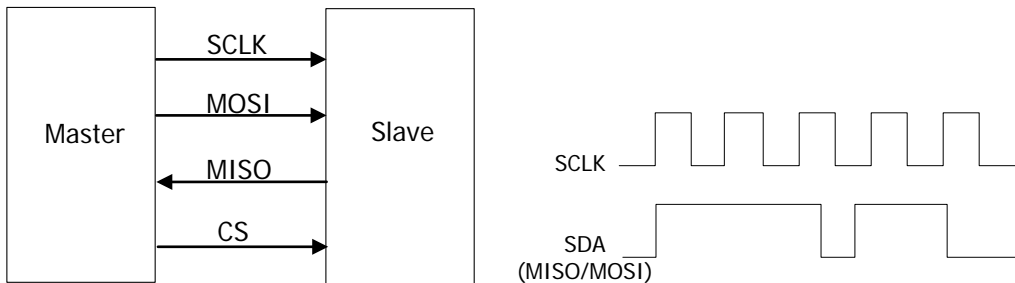

Figure 8-1 SPI Serial Bus



**SCLK:** SDA is sampled on the rising or falling edge of clock.

**SDA:** represents the data channel.

Press **MATH** → **Decode1** → **Decoder** to select "SPI" and open SPI decoding function menu.

1. Press **Decode** to turn on or off the decoding function.
2. **CLK Setting**  
Press **CLK** to select any channel (CH1-CH4 or D0-D15) as the clock channel.
3. **MISO and MOSI Settings**  
Press **MISO** to select any channel (CH1-CH4 or D0-D15) as the MISO data channel. If "OFF" is selected, this data line is not set. You can use the same method to set the MOSI data line.  
**Note:** Press **Exchange** to switch the current signal sources of the clock channel and data channel.
4. **Copy Trigger**  
Press **CopyTrig** to copy the protocol trigger settings from the trigger system and set the corresponding decoding parameters automatically. During SPI decoding, this function is valid only when the trigger type is SPI trigger. You can copy the settings of clock, data channel, data bits, edge, type (CS/Timeout), CS channel, CS polarity and timeout time as well as set the data polarity to positive.



## 5. Mode

- Timeout: you can perform frame synchronization according to the timeout and the timeout must be greater than half of the clock cycle.
- CS: it contains a chip select line (CS). You can perform frame synchronization according to CS. Press **Mode** to select "CS" and enter the CS mode. At this point, you can select CS signal line and CS polarity. The CS signal line can be CH1-CH4 or D0-D15. The CS polarity can be "" (high level is valid, namely the instrument starts transmitting data when the CS is high level) or "" (low level is valid, namely the instrument starts transmitting data when the CS is low level).



## 6. Timeout

When there are only two lines, the decoder can find the right start frame according to the timeout. The timeout must be greater than the maximum clock pulse width and less than the idle time between frames. For the setting method, please refer to the introduction in "**Parameter Setting Method**".

## 7. Edge Setting

Press **Edge** to set the instrument to sample MISO and MOSI on the rising edge () or falling edge () of CLK.

## 8. Polarity Setting

Press **Polarity** to set the polarity of the SDA data line to  (high level is 1) or  (low level is 1).

## 9. Width Setting

Press **Width** to set the number of digits per frame of data and the setting range is from 4 to 32.

## 10. Order

Press **Order** to select "LSB" or "MSB" and the default is MSB.

## 11. Display-related Setting

For more details, please refer to the introduction in "**Display-related Setting**" of parallel decoding.

## 12. Event Table

The event table displays the decoded data, the corresponding line number and time in table format. Press **Evt.Table** → **EventTable** to select "ON" (**Note:** This operation is only available when **MATH** → **Decode1** / **Decode2** → **Decode** is set to "ON") to enter the event table interface.

**Format:** set "Data" display format in the event table to HEX, DEC or ASC.

**Focus:** press this key and turn  to browse the "Data" item.

**View:** select the display form of the event table. If "Packets" is selected, the time and data are displayed in the event table; if "Details" is selected, the detailed data of the specified row will be displayed in the event table; if "Payload" is selected, all data of the specified column will be displayed in the event table. When different view is selected, the export format of the data table will change accordingly.

**Data:** select the data column to be viewed in the "Details" or "Payload" view. During SPI decoding, if the MISO and MOSI data lines are set at the same time, you can specify to display the data of MISO or MOSI.

**Order:** select the display type of decoding result in the event table to "Ascend" or "Descend".

**Export:** if a USB storage device (FAT32 format, flash memory) is currently connected to the instrument, press this softkey to export the data table to the external USB storage device in CSV format ("Packets" is selected) or HEX format ("Payload" or "Details" is selected).

### 13. Decoding Configuration

Press **Configure** to enter the decoding configuration submenu.

- Press **Label** to enable or disable the label display function. When "ON" is selected, the bus label will be displayed at the upper left of the bus (the bus display is turned on).
- Press **Line** to enable or disable the bus display function. When "ON" is selected, the bus will be displayed on the screen. You can use "**Pos**" to adjust the vertical display position of the bus.
- Press **Format** to enable or disable the format display function. When "ON" is selected, the current bus display format will be displayed on the right side of the label display (the bus display is turned on). You can use "**Format**" to set the display format of the bus.
- Press **Endian** to enable or disable the endian display function. When "ON" is selected, the current bus endian will be displayed on the right side of the format display (the bus display is turned on). You can use "**Order**" to set the bus endian.
- Press **Width** to enable or disable the width display function. When "ON" is selected, the number of digits per frame data will be displayed on the right side of the endian display (the bus display is turned on). You can use "**Width**" to set the number of digits per frame data.
- **Dig.Sa** menu displays the current digital sample rate which relates to the data source selected currently. When the data source is "Trace", the digital sample rate relates to the horizontal time base.

**Note:** By default, MSO1000Z/DS1000Z uses "Trace" as the data source.





## Chapter 9 Reference Waveform



In the actual test process, you can compare the waveform with the reference waveform to determine the cause of failure.

The contents of this chapter:

- To Enable REF Function
- To Select REF Source
- To Adjust REF Waveform Display
- To Save to Internal Memory
- To Set the Color
- To Reset the Reference Waveform
- To Export to Internal or External Memory
- To Import from Internal or External Memory

## To Enable REF Function

Press **REF** in the vertical control area (VERTICAL) at the front panel to enable the REF function.

MSO1000Z/DS1000Z provides 10 reference waveform channels. Press **Channel** and use  to set the desired reference channel to on or off and the channel icon (for example, ) of the channel enabled will be displayed at the left side of the screen grid.





When the REF function is enabled, you can select different color for each reference waveform, set the source of each reference channel, adjust the vertical scale and position of the reference waveform and save the reference waveform to internal or external memory as well as recall it when needed. For the details, please refer to the introductions below.

## To Select REF Source

Press **Current** and use  to select any of the reference channels (Ref1 to Ref10) enabled and then press **Source** to specify a reference source (CH1-CH4, MATH or D0-D15) for this channel.

## To Adjust REF Waveform Display

You can adjust the reference waveform specified in **Current**.

Press **REF** to enable the REF function. Press **Offset** and use  to adjust the vertical position of the reference waveform and press **Scale** and use  to adjust the vertical scale of the reference waveform. At this point, you can also directly rotate **VERTICAL**  **POSITION** and **VERTICAL**  **SCALE** to adjust the vertical position and scale respectively.



## To Save to Internal Memory

Press **Save** to save the waveform (screen region) in the specified source to the internal memory as reference waveform.

**Note:** This operation only saves the reference waveform in the volatile memory and the waveform will be cleared at power-off.

## To Set the Color

MSO1000Z/DS1000Z series oscilloscope provides five colors (light gray, green, light blue, magenta and orange) to mark the reference waveforms of different channels in order to distinguish them.

Press **Current** and use  to select any of the reference channels (Ref1-Ref10) enabled. Then, press **Color** to specify a different color for the reference waveform of that channel. The corresponding icon at the left of the channel currently selected will be filled with the specified color, for example, .

## To Reset the Reference Waveform

Press **Reset** and the reference waveform returns to the position where the source channel waveform is located when the **Save** operation was executed.

## To Export to Internal or External Memory

Users can also save the reference waveform to the internal flash memory or external USB storage device. The file format of the reference waveform is "\*.ref".

**Note:** MSO1000Z/DS1000Z only supports the flash memory USB storage device of FAT32 format.

Press **Export** to enter the file store interface. Please refer to the relative descriptions in "**Store and Recall**" to save the reference waveform to the internal or external memory.

## To Import from Internal or External Memory

Users can also import the reference waveform stored in the internal flash memory or external USB storage device to the internal memory.

**Note:** MSO1000Z/DS1000Z only supports the flash memory USB storage device of FAT32 format.

Press **Import** to enter the file recall interface. Please refer to the relative descriptions in "**Store and Recall**" to import the reference waveform to the internal memory of the instrument.



## Chapter 10 Pass/Fail Test

During the product design and manufacture process, you usually need to monitor the change of the signal or judge whether the product is up to standard. The pass/fail test function of MSO1000Z/DS1000Z oscilloscope can fulfill this task perfectly.

The contents of this chapter:

- To Enable Pass/Fail Test
- To Select Source
- Mask Range
- Test and Output
- To Save the Test Mask
- To Load the Test Mask

## To Enable Pass/Fail Test

Press **Utility** → **Pass/Fail** → **Enable** to select "ON". The blue shadow area denotes the failure area and if the waveform measured at certain time point during the measurement process passes through the failure area, it will be treated as failed frame. Press **Operate** to select "▶" to start testing and select "■" to stop testing.  
**Note:** When the time base is set to X-Y, ROLL or the horizontal time base is set to 200 ms/div or slower under YT mode and the instrument enter the "slow sweep" mode, the pass/fail test function is not available.

When the test function is enabled, you can set the output form of the test results. For the details, please refer to the introduction in "**Test and Output**". You can also select the signal source, set the test mask range as well as save and recall the test mask. For the details, refer to the introductions below.



## To Select Source

Before selecting the source, you need to connect the signal under test to the analog channel input terminal of the oscilloscope. Press **Source** to select the channel (CH1-CH4) to be tested.

**Note:** Only channels enabled can be selected.

## Mask Range

Users can define their desired test mask range. Press **Range** → **MaskRange** to set the mask region to "Screen" or "Cursor". The default is "Screen".

When "Screen" is selected, the entire waveform display area is defined as the mask region. When "Cursor" is selected, two gray cursor lines appear on the screen. At this point, press **CursorA** and **CursorB**; then, use  to adjust the positions of the two cursor lines respectively. Or, press **CursorAB** and use  to adjust the positions of cursor A and cursor B at the same time. Thereby the mask region is determined.

When the mask region is determined, press **X Mask** and **Y Mask** respectively, rotate  to adjust the pass/fail mask range. Press **Create** to apply the mask currently created. The horizontal and vertical adjustment ranges are 0.02 div to 4.0 div and 0.04 div to 5.12 div respectively.

## Test and Output

You can set the output form of the test results by the following method.

Press **Stat.Disp** to select "ON" or "OFF". When "ON" is selected, the test results will be displayed at the upper right corner of the screen as shown in the figure below.

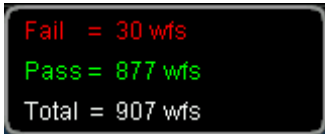

Press **Stat.Reset** to clear the current data and perform statistics on the test results again.

Press **StopOnFail** to select "ON" or "OFF".

- ON: when failed waveforms are detected, the oscilloscope will stop the test and enter the "STOP" state. At this point, if **Stat.Disp** is turned on, the last statistic results will be displayed on the screen; if **Aux Out** is turned on, a pulse is output from the **[Trigger Out]** connector at the rear panel.
- OFF: the oscilloscope will continue with the test even though failed waveforms are detected. The test results on the screen will update continuously. If **Aux Out** is turned on, a pulse will be output from the **[Trigger Out]** connector at the rear panel each time a failed waveform is detected.

Press **Output** to select "🔊" or "🔇".

- 🔊: when failed waveforms are detected, the instrument displays the statistic results and outputs a pulse.
- 🔇: when failed waveforms are detected, the instrument displays the statistic results and outputs a pulse and the beeper sounds (not related to the on/off state of the sound).

Press **AuxOut** to quickly turn "ON" or "OFF" the output of test results from the **[Trigger Out]** connector at the rear panel. When a failed waveform is detected, the oscilloscope outputs a negative pulse from the **[Trigger Out]** connector at the rear panel; when no failed waveform is detected, the instrument will output low level continuously.

## To Save the Test Mask

Users can save the current test mask to the internal flash memory or external USB storage device. The file format of the test mask file is "\*.pf".

**Note:** MSO1000Z/DS1000Z only supports the flash memory USB storage device of FAT32 format.

Press **Save** to enter the file store interface. Please refer to the relative descriptions in "**Store and Recall**" to save the test mask file to the internal or external memory.

## To Load the Test Mask

Users can also load the test mask files (\*.pf) stored in the internal flash memory or external USB storage device to the internal memory.

**Note:** MSO1000Z/DS1000Z only supports the flash memory USB storage device of FAT32 format.

Press **Load** to enter the file recall interface. Please refer to the relative descriptions in "**Store and Recall**" to load the test masks to the internal memory of the instrument.



# Chapter 11 Waveform Record

Waveform record can record the waveforms of the analog input channels (CH1-CH4) and the digital channels (D0-D15). Waveform playback can provide better waveform analysis effect.

**Note:** The horizontal time base must be set to Y-T mode during waveform record.

The contents of this chapter:

- Common Settings
- Playback Option
- Record Option

## Common Settings

Press **Utility** → **Record** → **Record** to turn on or off the waveform record function.

### 1. Record Waveform

Before recording the waveform, you can refer to the introduction in "**Record Option**" to set the waveform recording parameters. Press **Record** to start recording the waveform. During the recording, the current recording information as shown in the figure below is displayed at the upper right corner of the screen. "●" in the menu changes to "■" automatically. At this point, press **Record** again to stop recording.



#### Tip

Under the waveform recording menu, pressing **RUN/STOP** can also start and stop the recording.

### 2. Play

Press **Play** to start playing the waveform recorded. For more details, please refer to the introduction in "**Playback Option**".

### 3. Stop

During the playback, you can press **Stop** to stop the playback.

### 4. Current Frame



Press **Current** and use  to set the current frame. The default is the maximum number of frames recorded currently. During the setting, the screen will display the corresponding waveform of the current frame synchronously, namely manual playback.

### 5. Step Direction

Press **Step Dir** to select the single frame playback direction of the recorded waveform.

- **SINGLE▶**: press **SINGLE** to play the single frame forward (namely the single frame playback sequence is the same as the waveform record sequence) and the number of the frame is incremental.
- **SINGLE◀**: press **SINGLE** to play the single frame backward (namely the single frame playback sequence is opposite to the waveform record sequence) and the number of the frame is decremental.

### 6. The Last/First Frame

You can view the last or first frame of waveform. Pressing  can jump to the last frame of the recorded waveform; pressing  can jump to the first frame of the recorded waveform.

## Playback Option



Waveform playback can play back the waveforms currently recorded. During the playback, the information as shown in the figure below is displayed at the upper right corner of the screen. The data at the left side of the figure indicates the specific frame currently displayed on the screen. During the playback, this value would change continuously. The data at the right side of the figure indicates the maximum number of frames recorded currently.



Before playing back the waveform, you can press **Play Opt** to set the playback parameters.



### 1. Play Mode

Press **Mode** to set the playback mode to cycle or single.

- : cycle playback. Play from the start frame to the end frame and then repeat until you stop it manually.
- : single playback. Play from the start frame to the end frame and then stop.

### 2. Play Direction

Press **Dir** to set the play direction to positive or negative direction.

- : positive direction. Play from the start frame to the end frame.
- : negative direction. Play from the end frame to the start frame.

### 3. Interval

Press **Interval** to set the time interval of playback. The range available is from 100 ns to 10 s and the default is 100 ns. For the setting method, please refer to the introduction in "**Parameter Setting Method**".

### 4. Start Frame

Press **Start** to set the start frame of playback. The default is 1 and the maximum is the maximum number of frames recorded. For the setting method, please refer to the introduction in "**Parameter Setting Method**".

### 5. End Frame

Press **End** to set the end frame of the playback. The default is the total number of frames of the waveform recorded. For the setting method, please refer to the introduction in "**Parameter Setting Method**".

## Record Option

Before recording the waveform, you can press **Record Opt** to set the following parameters.

### 1. Interval

Press **Interval** to set the time interval between the frames in waveform recording and the range available is from 100 ns to 10 s. For the setting method, please refer to the introduction in "**Parameter Setting Method**".

### 2. Length



Press **Length** to set the number of waveform frames to be recorded currently. The range available is from 1 to the maximum number of frames can be recorded currently. For the setting method, please refer to the introduction in "**Parameter Setting Method**". Press **Set Max** to set the number of waveform frames to be recorded to the maximum number of frames can be recorded currently.

### 3. Max Length

The menu shows the maximum number of frames that can be recorded currently. As the capacity of the waveform memory is fixed, the more the number of points each frame of waveform has, the less the number of waveform frames can be recorded. Thus, the maximum end frame of waveform recording is decided by the memory depth currently selected. The less the memory depth, the more the number of waveform frames can be recorded.

The current memory depth refers to the number of waveform points per frame.  $\text{Memory depth} = \text{Sample rate} \times \text{Horizontal time base} \times \text{Number of grids horizontally on the screen}$ ; wherein, for MSO1000Z/DS1000Z, "Number of grids horizontally on the screen" is 12. Therefore, the maximum end frame of waveform recording is also related to the "Sample rate" and "Horizontal time base".

### 4. Beep

- : the beeper does not sound at the end of recording.
- : the beeper sounds at the end of recording.

# Chapter 12 Display Control

You can set the type, persistence time and brightness of waveform display as well as the grid type and grid brightness of the screen display.

The contents of this chapter:

- To Select the Display Type
- To Set the Persistence Time
- To Set the Waveform Intensity
- To Set the Screen Grid
- To Set the Grid Brightness

## To Select the Display Type

Press **Display** → **Type** to set the waveform display mode to "Vectors" or "Dots".

- Vectors: the sample points are connected by lines and displayed, as shown in the figure below. Normally, this mode can provide the most vivid waveform to view the steep edge of the waveform (such as square waveform).
- Dots: display the sample points directly as shown in the figure below. You can directly view each sample point and use the cursor to measure the X and Y values of the sample point.



Vectors Display

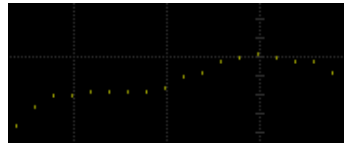

Dots Display

## To Set the Persistence Time

Press **Display** → **Persis.Time** to set the persistence time of the oscilloscope to Min, specific values (100 ms, 200 ms, 500 ms, 1 s, 5 s and 10 s) or Infinite.

In the following part, the frequency sweep signal of a sine waveform is used to demonstrate the waveform effects in different persistence times.

### 1. Min

Enable to view waveform changing in high refresh rate.

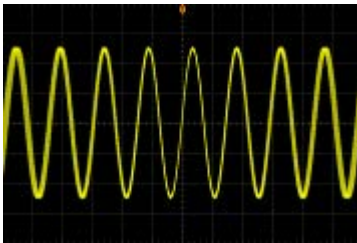

### 2. Specific Values

Enable to observe glitch that changes relatively slowly or glitch with low occurrence probability. The persistence time can be set to 100 ms, 200 ms, 500 ms, 1 s, 5 s or 10 s.



### 3. Infinite

In this mode, the oscilloscope displays the waveform newly acquired without clearing the waveforms acquired formerly. The waveforms acquired formerly will be displayed in relatively low-brightness color and the waveform newly acquired will be displayed in normal brightness and color. Infinite persistence can be used to measure noise and jitter and to capture incidental events.

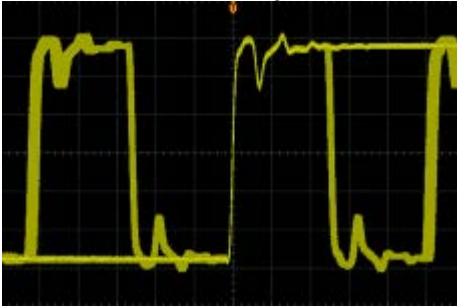



## To Set the Waveform Intensity

Press **Display** → **Intensity** or turn  in non-menu operation to adjust the waveform brightness of the channel. The default is 60% and the range available is from 0% to 100%.

## To Set the Screen Grid

Press **Display** → **Grid** to set the screen grid type.

- : turn the background grid and coordinate on.
- : turn the background grid off.
- : turn the background grid and coordinate off.

## To Set the Grid Brightness

Press **Display** → **Brightness** to set the brightness of the screen grid. Turn  to adjust the grid brightness. The default is 50% and the range available is from 0% to 100%.





# Chapter 13 Signal Source

MSO1000Z/DS1000Z combines signal generator and oscilloscope in one instrument by providing a built-in dual-channel, 25MHz signal generator, thus providing convenience for engineers who need to use the signal generator and oscilloscope at the same time. This chapter introduces how to use the built-in signal generator. As the functions and setting methods of source 1 and source 2 are the same, this chapter takes source 1 for illustration.

Press **Source** to enter the signal generator control menu.

- Press **Output** to enable or disable the signal output. When it is enabled, the **[Source 1]** connector at the rear panel outputs a signal according to the current setting.
- Press **Src1Conf** to set the signal type and the signal parameters.
- Pressing **AlignPhase** can align the phases of the signals output from source 1 and source 2.
- Press **StatusDisp** to view the parameter settings of source 1 and source 2, such as the frequency, amplitude, offset, phase, modulation type and modulation frequency, etc.
- Press **RecoveryCalls** to set the output signal type and parameters to be recalled when the oscilloscope is powered on again after power-off. You can select "Last" or "Default".
- Pressing **Factory** can restore the default settings of the signal source separately.

**Note:** The function of **Source** → **Output** is the same with that of **Source** → **Src1Conf** → **Output**.

The contents of this chapter:

- To Output Basic Waveform
- To Output Built-in Waveform
- To Output Arbitrary Waveform
- Modulation

## To Output Basic Waveform

MSO1000Z/DS1000Z built-in signal source can output a variety of basic waveforms, including sine, square, ramp, pulse, DC and noise.

### To Output Sine

Press **Src1Conf** to open the waveform setting menu. Press **Wave** and select "Sine". At this point, you can set the sine parameters.

#### 1. Source 1 output

Press **Output** to turn on or off the signal output. This function is the same with that of **Source** → **Output**. When "ON" is selected, the signal set currently is output from the **[Source 1]** connector at the rear panel.

#### 2. Set the frequency

Press **Frequency** to set the frequency of the signal. For the setting method, please refer to the introduction in "**Parameter Setting Method**". For different waveforms, the frequency ranges are different.

Sine: 100 mHz to 25 MHz

Square: 100 mHz to 15 MHz

Ramp: 100 mHz to 100 kHz

Pulse: 100 mHz to 1 MHz

DC and noise: there is no frequency parameter.

#### 3. Set the amplitude

Press **Amplitude** to set the amplitude of the signal. For the setting method, please refer to the introduction in "**Parameter Setting Method**". When the impedance is set to HighZ, the range is from 20 mVpp to 5 Vpp; when the impedance is set to 50 Ω, the range is from 10 mVpp to 2.5 Vpp.

#### 4. Set the DC offset voltage

Press **Offset** to set the DC offset of the signal. For the setting method, please refer to the introduction in "**Parameter Setting Method**". When the impedance is HighZ, the range is from  $(-2.5\text{ V} + \text{the current amplitude}/2)$  to  $(2.5\text{ V} - \text{the current amplitude}/2)$ ; when the impedance is set to 50 Ω, the range is from  $(-1.25\text{ V} + \text{the current amplitude}/2)$  to  $(1.25\text{ V} - \text{the current amplitude}/2)$ .

#### 5. Set the start phase

Press **StartPhase** to set the start phase of the signal. For the setting method, please refer to the introduction in "**Parameter Setting Method**". The range is from 0° to 360° .

## 6. Align phase

Pressing **AlignPhase** will re-configure the two channels to output according to the preset frequency and phase. For two signals of which the frequencies are the same or are multiples, this operation can align their phases. Acquire the waveforms of the two channels using the oscilloscope and display the waveforms stably. After switching the channel status, the phase deviation between the two waveforms is changed. At this point, press **AlignPhase** and the phase deviation shown on the oscilloscope will restore to the current phase deviation between the two waveforms automatically.

## 7. Modulation

Press **Src1Mod** to enter the modulation setting interface. For detailed introduction of the modulation function, please refer to "**Modulation**".

**Note:** When "Pulse", "DC" or "Noise" is selected by pressing **Wave**, there is not this setting.

## 8. Set the impedance

Press **Impedance** to set the output impedance of the signal generator. It can be set to "HighZ" or "50Ω".

## To Output Square

Press **Src1Conf** to open the waveform setting menu. Press **Wave** and select "Square". At this point, you can set the square parameters. For the detailed setting method, refer to the introduction in "**To Output Sine**". The duty cycle of square is fixed at 50%.

## To Output Ramp

Press **Src1Conf** to open the waveform setting menu. Press **Wave** and select "Ramp". At this point, you can set the ramp parameters. For the detailed setting method, refer to the introduction in "**To Output Sine**". This section only introduces "Symmetry".

Symmetry is defined as the percentage that the rising period of the ramp takes up in the whole period.

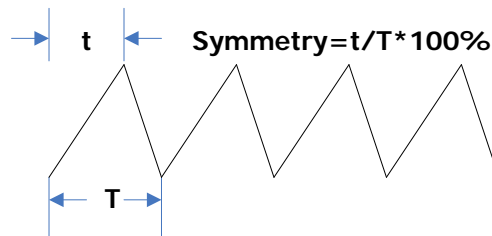

Figure 13-1 Symmetry Definition

Press **Symmetry** to set the symmetry of the ramp waveform. For the setting method, please refer to the introduction in "**Parameter Setting Method**". The range is from 0% to 100%.

## To Output Pulse

Press **Src1Conf** to open the waveform setting menu. Press **Wave** and select "Pulse". At this point, you can set the pulse parameters. For the detailed setting method, refer to the introduction in "**To Output Sine**". This section only introduces "DutyCycle".

Duty cycle is defined as the percentage that the high level takes up in the whole pulse period.

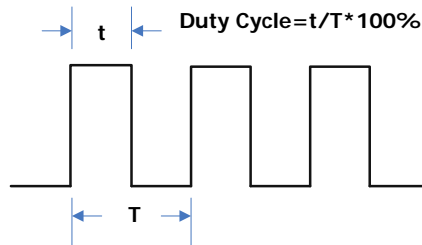

Figure 13-2 Duty Cycle Definition

Press **DutyCycle** to set the duty cycle of the pulse. For the setting method, please refer to the introduction in "**Parameter Setting Method**". The range is from 10% to 90%.

## To Output DC

Press **Src1Conf** to open the waveform setting menu. Press **Wave** and select "DC". At this point, you can output a DC signal with the specified offset and impedance.

### 1. Source 1 output

Press **Output** to turn on or off the signal output.

### 2. Set the offset

Press **Offset** to set the offset of the DC signal. For the setting method, please refer to the introduction in "**Parameter Setting Method**". When the impedance is HighZ, the range is from -2.5 V to +2.5 V; when the impedance is set to 50  $\Omega$ , the range is from -1.25 V to +1.25 V.

### 3. Set the impedance

Press **Impedance** to set the output impedance of the signal generator. It can be set to "HighZ" or "50 $\Omega$ ".

## To Output Noise

Press **Src1Conf** to open the waveform setting menu. Press **Wave** and select "Noise". At this point, you can output a noise signal with the specified amplitude, offset and impedance.

### 1. Source 1 output

Press **Output** to turn on or off the signal output.

### 2. Set the amplitude

Press **Amplitude** to set the amplitude of the signal. For the setting method, please refer to the introduction in "**Parameter Setting Method**". When the impedance is set to HighZ, the range is from 20 mVpp to 5 Vpp; when the impedance is set to 50  $\Omega$ , the range is from 10 mVpp to 2.5 Vpp.

### 3. Set the offset

Press **Offset** to set the DC offset of the noise signal. For the setting method, please refer to the introduction in "**Parameter Setting Method**". When the impedance is HighZ, the range is from  $(-2.5 \text{ V} + \text{the current amplitude}/2)$  to  $(2.5 \text{ V} - \text{the current amplitude}/2)$ ; when the impedance is set to 50  $\Omega$ , the range is from  $(-1.25 \text{ V} + \text{the current amplitude}/2)$  to  $(1.25 \text{ V} - \text{the current amplitude}/2)$ .

## To Output Built-in Waveform

MSO1000Z/DS1000Z series oscilloscope provides 7 kinds of built-in waveforms, including Sinc, ExpRise, ExpFall, ECG, Gauss, Lorentz and Haversine. Press **Src1Conf** to open the waveform setting menu. Press **Wave** and select "Built-in". At this point, you can set the output signal parameters according to the type of the built-in waveform selected.

### 1. Source 1 output

Press **Output** to turn on or off the signal output.

### 2. Select built-in waveform

Press **Built-In** to select any of the 7 built-in waveforms (as shown in the figures below).

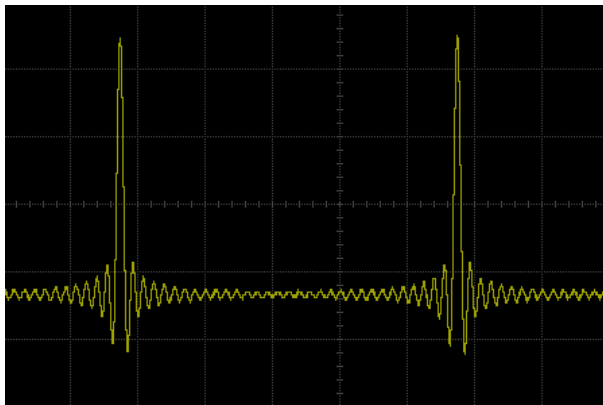

Figure 13-3 Built-in Waveform-Sinc

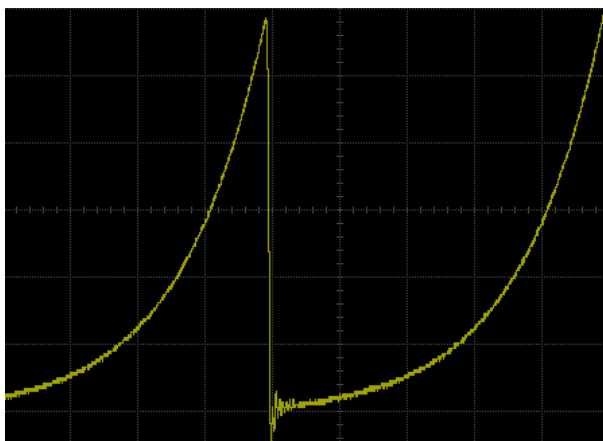

Figure 13-4 Built-in Waveform-ExpRise

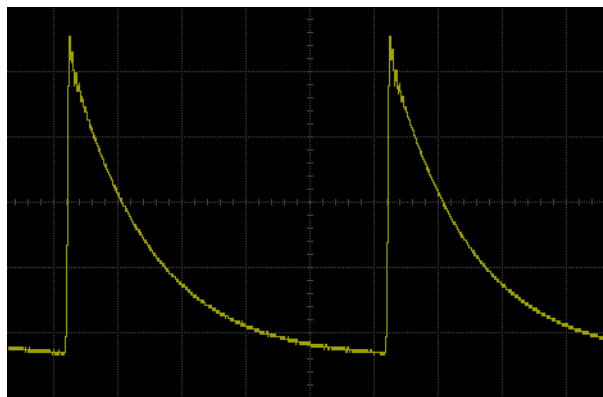

Figure 13-5 Built-in Waveform-ExpFall

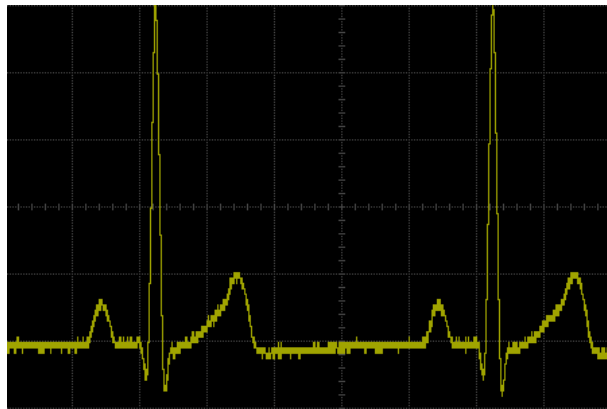

Figure 13-6 Built-in Waveform-ECG

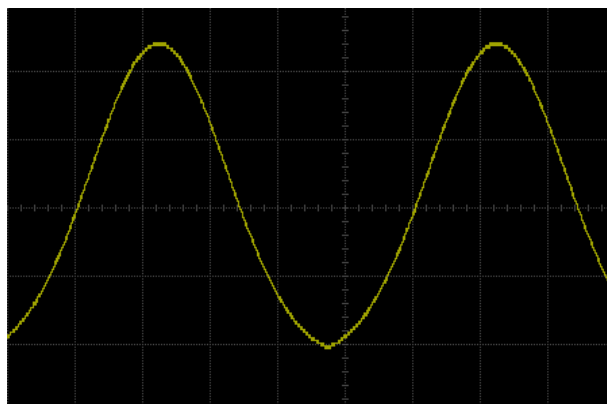

Figure 13-7 Built-in Waveform-Gauss

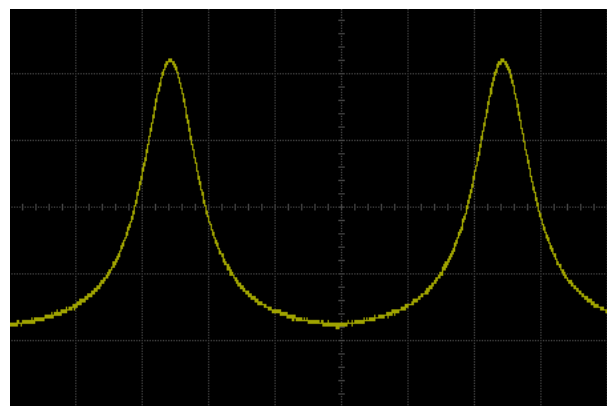

Figure 13-8 Built-in Waveform-Lorentz



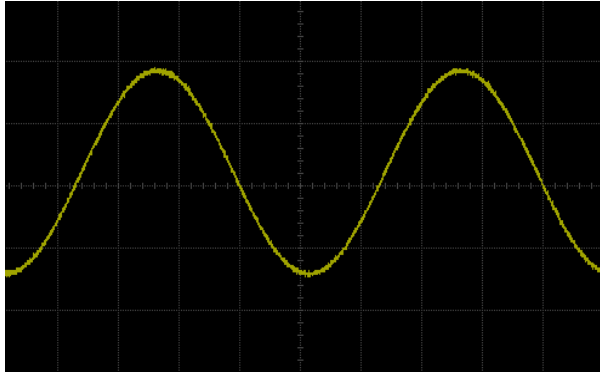

Figure 13-9 Built-in Waveform-Haversine

### 3. Set the frequency

Press **Frequency** to set the frequency of the signal. For the setting method, please refer to the introduction in "**Parameter Setting Method**". The range is from 100 mHz to 1 MHz.

### 4. Set the amplitude

Press **Amplitude** to set the amplitude of the signal. For the setting method, please refer to the introduction in "**Parameter Setting Method**". When the impedance is set to HighZ, the range is from 20 mVpp to 5 Vpp; when the impedance is set to 50  $\Omega$ , the range is from 10 mVpp to 2.5 Vpp.

### 5. Set the DC offset voltage

Press **Offset** to set the DC offset of the signal. For the setting method, please refer to the introduction in "**Parameter Setting Method**". When the impedance is HighZ, the range is from  $(-2.5 \text{ V} + \text{the current amplitude}/2)$  to  $(2.5 \text{ V} - \text{the current amplitude}/2)$ ; when the impedance is set to 50  $\Omega$ , the range is from  $(-1.25 \text{ V} + \text{the current amplitude}/2)$  to  $(1.25 \text{ V} - \text{the current amplitude}/2)$ .

### 6. Set the start phase

Press **StartPhase** to set the start phase of the signal. For the setting method, please refer to the introduction in "**Parameter Setting Method**". The range is from  $0^\circ$  to  $360^\circ$ .

### 7. Align Phase

Pressing **AlignPhase** will re-configure the two channels to output according to the preset frequency and phase. For two signals of which the frequencies are the same or are multiples, this operation can align their phases. Acquire the waveforms of the two channels using the oscilloscope and display the waveforms stably. After switching the channel status, the phase deviation between the two waveforms is changed. At this point, press **AlignPhase** and the phase deviation shown on the oscilloscope will restore to the current phase deviation between the two waveforms automatically.

## 8. Modulation

Press **Src1Mod** to enter the modulation setting interface. For detailed introduction of the modulation function, please refer to "**Modulation**".

**Note:** When "Pulse", "DC" or "Noise" is selected, the modulation menu will be hidden automatically.

## 9. Set the impedance

Press **Impedance** to set the output impedance of the signal generator. It can be set to "HighZ" or "50Ω".

# To Output Arbitrary Waveform

MSO1000Z/DS1000Z allows users to define their own arbitrary waveform and save it in the internal or external memory. At most 10 arbitrary waveforms can be stored in the internal memory. The user-defined waveform can contain 1 to 16384 data points (namely 1 pts to 16 kpts).

### 1. Source 1 output

Press **Output** to turn on or off the signal output.

### 2. Set the frequency

Press **Frequency** to set the frequency of the signal. For the setting method, please refer to the introduction in "**Parameter Setting Method**". The available range is from 100 mHz to 10 MHz.

### 3. Set the amplitude

Press **Amplitude** to set the amplitude of the signal. For the setting method, please refer to the introduction in "**Parameter Setting Method**". When the impedance is set to HighZ, the range is from 20 mVpp to 5 Vpp; when the impedance is set to 50 Ω, the range is from 10 mVpp to 2.5 Vpp.

### 4. Set the DC offset voltage

Press **Offset** to set the DC offset of the signal. For the setting method, please refer to the introduction in "**Parameter Setting Method**". When the impedance is HighZ, the range is from  $(-2.5\text{ V} + \text{the current amplitude}/2)$  to  $(2.5\text{ V} - \text{the current amplitude}/2)$ ; when the impedance is set to 50 Ω, the range is from  $(-1.25\text{ V} + \text{the current amplitude}/2)$  to  $(1.25\text{ V} - \text{the current amplitude}/2)$ .

### 5. Set the start phase

Press **StartPhase** to set the start phase of the signal. For the setting method, please refer to the introduction in "**Parameter Setting Method**". The range is from 0° to 360°.

## 6. Align Phase

The align phase operation is for the two channels. Pressing **AlignPhase** will re-configure the two channels to output according to the preset frequency and phase. For two signals of which the frequencies are the same or are multiples, this operation can align their phases. Acquire the waveforms of the two channels using the oscilloscope and display the waveforms stably. After switching the channel status, the phase deviation between the two waveforms is changed. At this point, press **AlignPhase** and the phase deviation shown on the oscilloscope will restore to the current phase deviation between the two waveforms automatically.

## 7. Select waveform

Select the arbitrary waveform in the internal or external memory. For the detailed operation, please refer to the introduction in "**To Select Waveform**".

## 8. Create waveform

Users define their own arbitrary waveform. For the detailed operation, please refer to the introduction in "**To Create Waveform**".

## 9. Edit waveform

Edit the arbitrary waveform stored. For the detailed operation, please refer to the introduction in "**To Edit Waveform**".

## 10. Modulation

Press **Src1Mod** to enter the modulation setting interface. For detailed introduction of the modulation function, please refer to "**Modulation**".

## 11. Set the impedance

Press **Impedance** to set the output impedance of the signal generator. It can be set to "HighZ" or "50Ω".

The following section introduces how "**To Select Waveform**", "**To Create Waveform**" and "**To Edit Waveform**".

# To Select Waveform

Users can load the waveform stored or recall the channel signal waveform according to their needs.



- **Load**

Select arbitrary waveforms in the internal or external memory (D disk) for output. Press **Select** → **Load**, use  to select the desired waveform. For the detailed operation, please refer to the introduction in "**Store and Recall**".

- **Channel Signal**

Select the signals of analog channel (CH1-CH4) turned on currently for output.

Press **Select** → **CHSignal** to set the desired channel signal.

- Press **Source** to select the waveform of any of the channels turned on (CH1-CH4).
- Press **WaveRange** to set the waveform in the "Cursor" or "Screen" region for output. When "Cursor" is selected, Press **CursorA** or **CursorB** and use  to adjust the positions of the two orange cursor lines respectively; or press **CursorAB** and rotate  to adjust the positions of cursors A and B at the same time.
- Press **Probe** to set the probe ratio when the analog channel signal is recalled. You can select "0.1X", "0.2X", "0.5X", "1X", "2X" or "5X". For example, if the selected analog channel amplitude is 10 VPP and the probe ratio is "0.5X", the amplitude of the arbitrary waveform recalled is 5 VPP.
- Pressing **Load** can recall the channel signal selected.

You can also edit the waveform currently selected; for the details, refer to the introduction in "**To Edit Waveform**".

## To Create Waveform

Users can create arbitrary waveforms according to their needs. Press **Create** to enter the waveform creation menu.

### 1. Set the Number of Initial Points

The number of initial points refers to the number of editable points. By default, the number of editable points of arbitrary waveform created can be preset to 2 points. Point 1 is fixed at 0 s and point 2 is fixed at the middle of the period. Press **InitPoint** to set the number of editable points of the new waveform. For the setting method, please refer to the introduction in "**Parameter Setting Method**". The arbitrary waveform can contain up to 16384 (16 kpts) points.

### 2. Interpolation

Press **Interp** to turn on or off the interpolation mode between the points of the arbitrary waveform.

- **ON:** the waveform editor connects two points using a straight line.

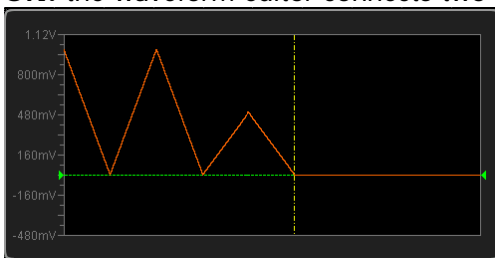

- **OFF:** the waveform editor will keep a constant voltage level between two points and create a ladder-like waveform.

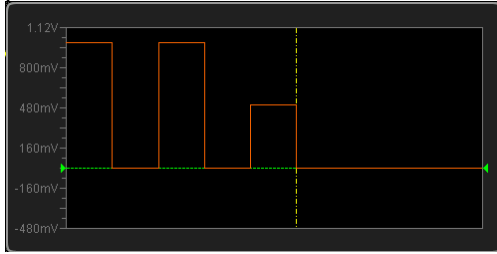

### 3. Zoom

Press **Zoom** to turn on or off the zoom function.

- **ON:** the waveform editing window only displays the current point.
- **OFF:** the waveform editing window displays all the initial points.

### 4. Current Point

Press **CurPoint** to set the point to be edited. The range is from 1 to the **initial points**. For the setting method, please refer to the introduction in "**Parameter Setting Method**".

### 5. Voltage

Press **Voltage** to set the voltage of the current point. The range is from -2.5 V to +2.5 V and the default is 0.000 mV. For the setting method, please refer to the introduction in "**Parameter Setting Method**".

### 6. Time

Press **Time** to set the duration of the current point. This setting is limited by the times of the previous point and following point. The time of point 1 is fixed at 0 s.

### 7. Insert

Press **Insert** to insert a new waveform point between the current point and the next point. At this time, the initial points increases by one. You can press **Insert** continuously to increase the editable point successively.

### 8. Delete

Press **Delete** to delete the current point from the waveform and connect the remaining points using the current interpolation mode.

**Note:** Point 1 cannot be deleted.

### 9. APPLy

Press **Apply** to finish editing the current waveform and output the edited waveform.

### 10. Save

Press **Save** to enter the file store interface. Please refer to the introduction in

"**Store and Recall**" to save the current waveform file in ".arb" format in the internal memory or external memory (you can overwrite the original file or save the current waveform again). You can select the arbitrary waveforms in the internal or external memory for output. For the details, refer to the introduction in "**To Select Waveform**".

## To Edit Waveform

Users can edit the waveform currently stored in the volatile memory. Press **Edit** to enter the waveform editing menu.

### 1. Interp

Press **Interp** to turn on or off the interpolation mode between the points of the waveform.

- **ON:** the waveform editor connects two points using a straight line.
- **OFF:** the waveform editor will keep a constant voltage level between the two points and create a ladder-like waveform when the interpolation is disabled.

### 2. Zoom

Press **Zoom** to turn on or off the zoom function.

- **ON:** the waveform editing window only displays the current point.
- **OFF:** the waveform editing window displays all the initial points.

### 3. Current Point

Press **CurPoint** to set the point to be edited. The range is from 1 to the **initial points**. For the setting method, please refer to the introduction in "**Parameter Setting Method**".

### 4. Voltage

Press **Voltage** to set the voltage of the current point. The range is from -2.5 V to +2.5 V and the default is 0.000 mV. For the setting method, please refer to the introduction in "**Parameter Setting Method**".

### 5. Time

Press **Time** to set the duration of the current point. This setting is limited by the times of the previous point and following point. The time of point 1 is fixed at 0 s. For the setting method, please refer to the introduction in "**Parameter Setting Method**".

### 6. Insert

Press **Insert** to insert a new waveform point in the middle position between the current point and the next point.

### 7. Delete

Press **Delete** to delete the current point from the waveform and connect the remaining points using the current interpolation mode.

**Note:** Point 1 cannot be deleted.

### 8. Apply

Press **Apply** to finish editing the current waveform.

### 9. Save

Press **Save** to enter the file store interface. Please refer to the introduction in "**Store and Recall**" to save the current waveform file in ".arb" format in the internal memory or external memory (you can overwrite the original file or save the current waveform again). You can select the arbitrary waveforms in the internal or external memory for output. For the details, refer to the introduction in "**To Select Waveform**".

## Modulation

The built-in signal generator of MSO1000Z/DS1000Z series oscilloscope supports amplitude modulation (AM) and frequency modulation (FM). The modulated waveform consists of the carrier waveform and modulating waveform. The carrier waveform is the waveform output from the signal generator and the modulating signal can be the built-in sine, square, ramp waveform or noise signal.

Press **Src1Mod** to open the source 1 modulation setting menu. Press **Modulation** to turn on or off the modulation function. Press **Mod.Type** to set the modulation type of the current signal to "AM" or "FM". Then, you can set the modulation parameters according to the selected modulation type.

## AM

AM (Amplitude Modulation), namely the amplitude of the carrier waveform changes with the amplitude of the modulating waveform, as shown in the figure below.

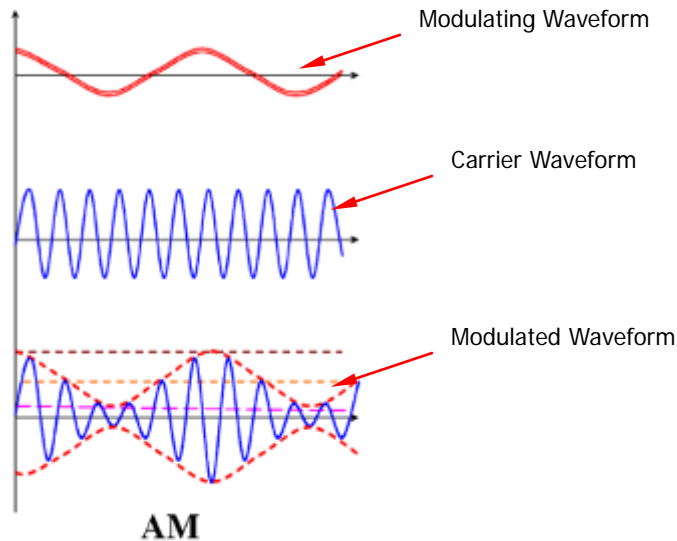

Figure 13-10 Amplitude Modulation

### 1. Select the Carrier Waveform

Press **Src1Conf** to enter the waveform setting interface. Press **Wave** to select the desired carrier.

**Note:** When "Pulse", "DC" or "Noise" is selected, the modulation menu will be hidden automatically.

### 2. Set the Carrier Parameters

After selecting the desired carrier, you can refer to the introduction in "**Parameter Setting Method**" to set the carrier parameters (frequency, amplitude, etc).

### 3. Select the Modulating Waveform

Press **Src1Mod** to open the source 1 modulation setting menu. Press **Shape** to select the desired modulating waveform, including sine, square, triangle waveform and noise.

### 4. Set the Modulation Frequency

Press **Frequency** to set the frequency of the modulating waveform. The range is from 1 Hz to 50 kHz. For the setting method, please refer to the introduction in "**Parameter Setting Method**".



### 5. Set the Modulation Depth

The modulation depth refers to the strength of the AM and is expressed in percentage. Press **Depth** to set the modulation depth of the modulating waveform. The range is from 0% to 120%. When it is set to 0%, the output amplitude is half of the carrier amplitude. When it is set to 100%, the output amplitude equals the carrier amplitude. When it is set to a value greater than 100%, envelop distortion will occur which must be avoided in actual circuit; at this point, the output of the instrument will not exceed 5 Vpp (the load is 50  $\Omega$ ).

## FM

FM (Frequency Modulation), namely the frequency of the carrier waveform changes with that of the modulating waveform, as shown in the figure below.

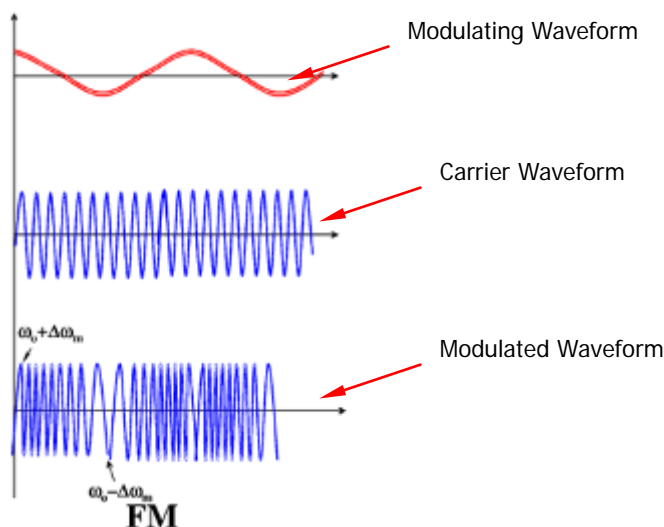

Figure 13-11 Frequency Modulation

#### 1. Select the Carrier Waveform

Press **Src1Conf** to enter the waveform setting interface. Press **Wave** to select the desired carrier.

**Note:** When "Pulse", "DC" or "Noise" is selected, the modulation menu will be hidden automatically.

#### 2. Set the Carrier Parameters

After selecting the desired carrier, you can refer to the introduction in "**Parameter Setting Method**" to set the carrier parameters (frequency, amplitude, etc).

#### 3. Select the Modulating Waveform

Press **Src1Mod** to open the source 1 modulation setting menu. Press **Shape** to select the desired modulating waveform, including sine, square, triangle

waveform and noise.

#### 4. Set the Modulation Frequency

Press **Frequency** to set the frequency of the modulating waveform. The range is from 1 Hz to 50 kHz.

#### 5. Set the Modulation Deviation

Press **Deviation** to set the deviation of the frequency of the modulating waveform relative to the carrier frequency. The range is from 0 Hz to the current carrier frequency and the sum of the frequency deviation and carrier frequency cannot be greater than the current carrier frequency upper limit. For the setting method, please refer to the introduction in "**Parameter Setting Method**".

## Chapter 14 Store and Recall

Users can save the current settings, waveforms, screen image and parameters of the oscilloscope in internal memory or external USB mass storage device (such as USB storage device) in various formats and recall the stored traces, settings or waveforms when needed.

**Note:** MSO1000Z/DS1000Z only supports the flash memory USB storage device of FAT32 format.

The contents of this chapter:

- Storage System
- Storage Type
- Internal Storage and Recall
- External Storage and Recall
- Disk Management
- Factory

## Storage System

Press **Storage** to enter the store and recall setting interface.

The internal memory (Local Disk) of this oscilloscope is 90.5 MByte. It provides a USB Host interface at the front panel to connect USB storage device for external storage. The USB storage device connected is marked as "Disk D".

## Storage Type

Press **Storage** → **Storage** to select the desired storage type. The default is "Picture". The storage and recall descriptions of each type are as follows.

### 1. Picture

Save the screen image to external memory in ".png", ".bmp8", ".bmp24", ".jpeg" or ".tiff" format. You can specify the file name and saving directory and save the corresponding parameter file (\*.txt) under the same directory using the same file name. This parameter file is the same as the "**Parameters**" function. The recall of image and parameter files is not supported.

After selecting this type:

Press **PicType** to select the desired storage format.

Press **Param** to enable or disable the parameter save function.

Press **Invert** to enable or disable the invert function.

Press **Color** to select the desired storage color. It can be set to "Gray" or "Color".

#### Tip

After a USB storage device (FAT32 format, flash memory) is connected, press  at the front panel to quickly save the current screen image under the root directory of the USB storage device.

### 2. Traces

Save the waveform data of all enabled channels (analog channel and digital channel) to the external memory in "\*.trc" format. When loading the traces file, display the waveform data on the screen directly. After the file is loaded, the loaded waveform will not change when you adjust the settings (such as the horizontal scale and vertical scale) of the oscilloscope.

#### Note:

- The reading and saving operations of the file in ".trc" format can only be completed on the oscilloscope.
- Press **Clear** to clear the loaded waveform; besides, other waveforms on the screen will also be cleared. (If the oscilloscope is in the "RUN" state, new

waveforms will be displayed on the screen.)

### 3. Waves

Save the main setting information (e.g. "On/Off" states of the channels, vertical scale and horizontal scale) and waveform data of all enabled channels (analog channel and digital channel) to the external memory in "\*.wfm" format. When the waves file is loaded, the system will set the oscilloscope based on its existing saved setting information of the oscilloscope and recall all the waveform data. When the loading is complete, the oscilloscope will be in the "STOP" state. Under such situation, you can adjust the waveform display by changing the setting (such as the horizontal scale and vertical scale) of the oscilloscope; or you can adopt the one-key measurement or cursor measurement to measure the waveform parameters.

#### Note:

- The reading and saving operations of the file in ".wfm" format can only be completed on the oscilloscope.
- If you set the oscilloscope to be in the "RUN" state, the oscilloscope will start over the waveform sampling. (That means, the loaded waveform data will be cleared.)

### 4. Setups

Save the settings of the oscilloscope to internal or external memory in "\*.stp" format. The stored settings can be recalled.

### 5. CSV

Save the screen waveform data of all enabled channels (analog channel and digital channel) or the memory data of the specified enabled channels to the external memory in "\*.csv" format. You can specify the file name and the saving directory and save the corresponding parameter file (\*.txt) under the same directory using the same file name. This parameter file is the same as the "**Parameters**" function. The recall of CSV and parameter files is not supported.

After selecting this type:

Press **DataSrc** to select "Screen" or "Memory". After selecting "Memory", press **Channel** to select the desired channel (**Note:** Only channels currently enabled can be selected).

Press **Param** to enable or disable the parameter save function.

Press **Sequence** to choose whether to add sequence numbers for the waveform points in the CSV file. You can select "ON" or "OFF" and the default is "ON" (namely add the sequence number).

### 6. Parameters







Save the parameters of the screen waveform to the external memory in "\*.txt" format. The parameter storage contains the system information (such as the

software and hardware version number) and the current setting information of the instrument (such as vertical, horizontal, trigger, etc). The recall of the parameter file is not supported.



## Internal Storage and Recall

"Setups" and "Param" (internal recall is not supported) in **Storage** support internal storage. In the following part, the storage and recall method and procedures of internal storage are introduced.

### 1. Save the specified oscilloscope setting in internal memory.

- 1) Connect a signal to the oscilloscope and obtain stable display.
- 2) Press **Storage** → **Storage** to select "Setups" or "Param" and press **Save** and use  to select "Local Disk" (blue shading) and press down  to open the local disk.
- 3) Press **New File** and use the pop-up keyboard to create a new file name. For the details, please refer to the introduction in "**To Create a New File or Folder**". If this type of file is saved in the internal memory, use  to select this file and then **Save** and **Delete** are illuminated. At this point, pressing down **Save** will execute the storage operation and the original file will be overwritten; pressing **Delete** will delete the original file. Use  to select  and then press down  to return to the previous directory.







### 2. Load the specified type of file in internal memory.

- 1) Press **Storage** → **Storage** to select "Setups" and then press **Load** and use  to select "Local Disk" and then press down  to open the local disk.
- 2) If this type file is saved in the internal memory, use  to select the desired file and press **Load** to load the file selected.



## External Storage and Recall

Before using external storage and recall, make sure that a USB storage device (FAT32 format, flash memory) is connected correctly. External storage supports all the types of files in **Storage** but in recall, "Picture", "CSV" and "Param" are not supported. In the following part, we will take "Traces" as an example to introduce the storage and recall method and procedures.

### 1. Save the specified type of file in the external USB storage device



- 1) Connect a signal to the oscilloscope and obtain stable display.
- 2) Press **Storage** → **Storage** to select "Traces". Press **Save** and use  to select "Disk D" and then press down  to open the USB storage device.
- 3) Use  to select the desired storage position. The file can be stored under the root directory or in a certain folder under the root directory of the USB storage device.  
**Note:** Pressing **NewFolder** can create a new folder. For the detailed, please refer to the introduction in "To Create a New File or Folder".
- 4) After the storage position is selected, press **New File** to create a new filename using the pop-up keyboard. For the details, please refer to the descriptions in "To Create a New File or Folder". If this type file is saved in the USB storage device, use  to select this file and then **Save** and **Delete** are illuminated. At this point, pressing down **Save** will execute the storage operation and the original file will be overwritten; pressing **Delete** will delete the original file. Use  to select  and then press down  to return to the previous directory.
- 5) Press **OK** to execute the saving operation.

### 2. Load the specified type of file in the external USB storage device

- 1) Press **Storage** → **Storage** to select "Traces" and then press **Load** and use  to select "Disk D". Press down  to open the USB storage device.
- 2) If this type file is saved in the USB storage device, use  to select the desired file and press **Load** to load the file selected.



## Disk Management

Press **Storage** → **DiskManage** to turn on the disk management interface as shown in Figure 14-1 and use  to select the desired disk. The disk currently selected is displayed in blue shading. Press down  to open the disk selected.

Execute the following operations through the disk management menu:

- To Select File Type
- To Create a New File or Folder
- To Delete a File or Folder
- To Rename a File or Folder
- To Clear the Local Memory

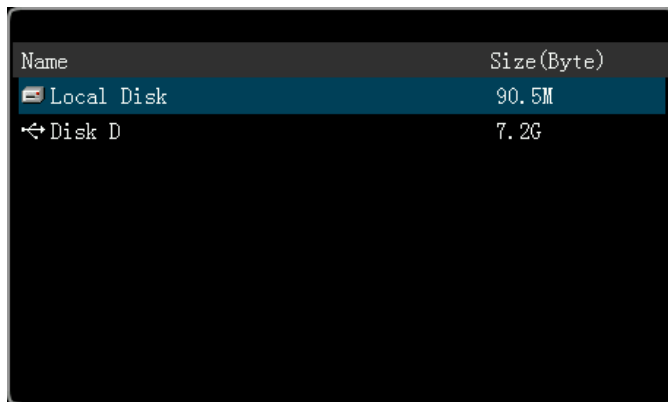

Figure 14-1 Disk Management Interface

### To Select File Type

Except the file types in **Storage**, the oscilloscope can also display files for advanced applications such as mask file of the Pass/Fail test (\*.pf), upgrade file (.gel) and reference waveform file (\*.ref).

Press **Storage** → **DiskManage** → **File Type** to select the desired file type. The default is "\*.\*". Under the current directory, only files of which the suffix of the file name matches with the file type selected will be displayed in the current disk.

## To Create a New File or Folder

This operation is only valid in external storage. Before using external disk, make sure that a USB storage device (FAT32 format, flash memory) is connected correctly.

First, press **Storage** → **DiskManage** and use  to select and open the external disk ("Disk D"). Then, select the desired directory under which you need to create a new file or folder. The default is the root directory of the USB storage device. Finally, select the desired file type and press **New File** or press **New Folder** directly to turn on the interface as shown in the figure below.

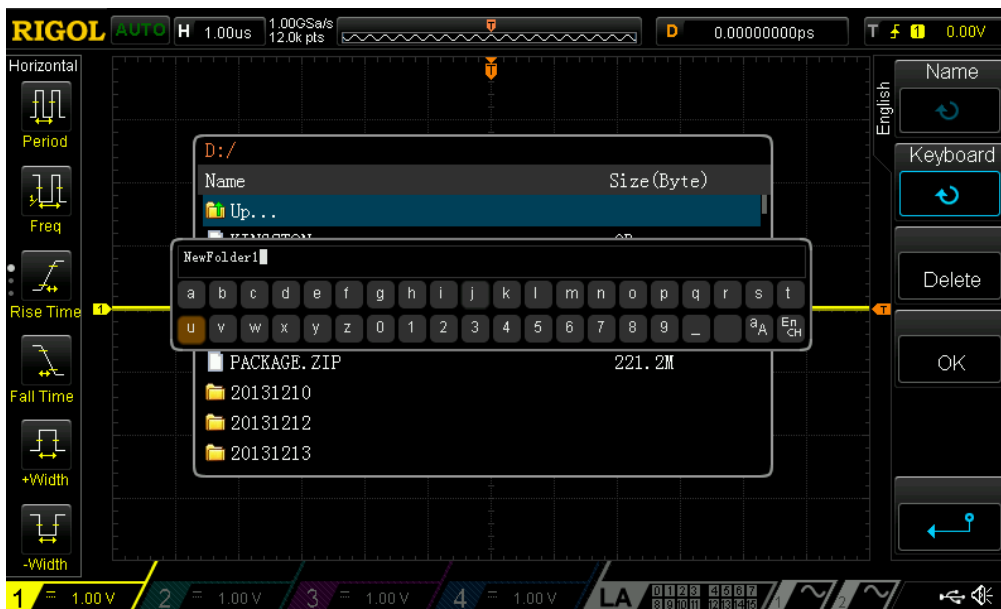



Figure 14-2 To Create a New File or Folder





This oscilloscope supports Chinese/English input method. The file name or folder name can contain letters, numbers, underscores, spaces and Chinese characters and the length of the characters is limited to 31 bytes. The following part introduces how to input a file name or folder name using Chinese/English input method.

**Operation Tip**  
During the name input, use the menu softkeys to select different operation areas, then turn  to select the desired content and press down  to input the content selected.

## English Input Method

For example, create a file or folder with the name "Filename".

1. Press **Keyboard**.

- 1) Use  to select English input method "En" and uppercase input state "A<sub>A</sub>".
- 2) Use  to input the letter "F". If the input is wrong, press **Delete** to delete the character input.
- 3) Use  to select lowercase input state "a<sub>A</sub>".
- 4) Use  to input the remaining letters "ilename".

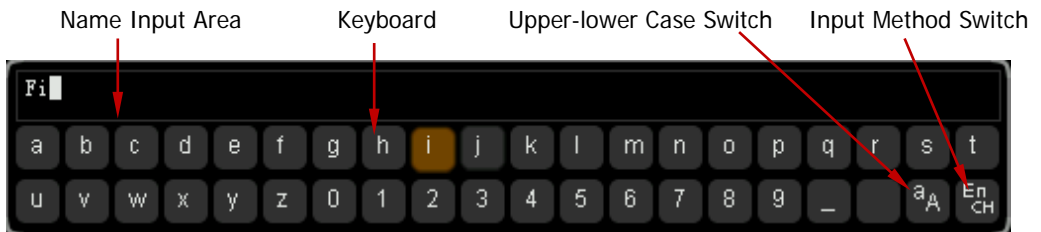



2. During the name input, you can press **Name** to select the "Name Input Area" and use  to move the cursor, then press **Delete** to delete the characters at the left of the cursor one by one.
3. After finishing the input, press **OK** and the oscilloscope will create a folder or a specified type of file with this name under the current directory.

## Chinese Input Method

For example, create a file or folder with the name "文件名".

1. Press **Keyboard**.
  - 1) Use  to select Chinese input method "中".
 



**Note:** **Chinese** is added in the menu items at the right of the screen.
  - 2) Use  to input the pinyin "wen". If the input is wrong, press **Delete** to delete the pinyin input. After "wen" is input, a series of Chinese characters appear in the "Chinese Character Selecting Area".
  - 3) Press **Chinese** and use  to select and input "文".
  - 4) Use the same method to input "件" and "名".





2. During the name input, you can press **Name** to select the "Name Input Area" and then press **Delete** to delete the Chinese characters at the left of the cursor one by one.
3. After finishing the input, press **OK** and the oscilloscope will create a folder or a specified type of file with this name under the current directory.

## To Delete a File or Folder



Folder operation is valid only in external storage. Before using the external disk, make sure that a USB storage device (FAT32 format, flash memory) is connected correctly.

1. Delete a file in internal memory.
  - 1) Press **Storage** → **DiskManage** and use  to select and open the local disk ("local Disk").
  - 2) Press **File Type** to select the desired type of file to be deleted.
  - 3) Use  to select the desired file to be deleted.
  - 4) Press **Delete** → **OK** to delete the file selected.
2. Delete a file or folder in external memory.

Press **Storage** → **DiskManage** and use  to select and open the external disk ("Disk D"). Use  to select the file (or folder) to be deleted and then press **Delete** → **OK** to delete the selected file (or folder).

## To Rename a File or Folder

Rename operation is valid only in external storage. Before using the external disk, make sure that a USB storage device (FAT32 format, flash memory) is connected correctly.

Press **Storage** → **DiskManage** and use  to select and open the external disk ("Disk D"). Use  to select the desired file or folder to rename and then press **Rename** to turn on the rename interface. For specific operations, please refer to the descriptions in "To Create a New File or Folder".

## To Clear the Local Memory



Press **Storage** → **DiskManage** and select "Local Disk". You can press **FlashErase** → **OK** to delete all the files stored in the local memory.

## Factory

Press **Storage** → **Default** to return the oscilloscope to its factory state (refer to the table below).

Table 14-1 Factory

Parameter	Factory
Horizontal Setting (HORIZONTAL)	
Vertical Setting (VERTICAL)	
Acquisition Setting (Acquire)	
Trigger Setting (TRIGGER)	
Display Setting (Display)	
Signal Source (Source)	
Cursor Setting (Cursor)	
Storage Setting (Storage)	
Utility Function Setting (Utility)	
Math Operation Setting (MATH→Math)	
LA	
Protocol Decoding (MATH→ Decode 1/Decode 2)	
Reference Waveform Setting (REF)	
<b>Horizontal Setting (HORIZONTAL)</b>	
Horizontal Time Base	1 $\mu$ s
Horizontal Offset	0 s
Delayed Sweep	OFF
Time Base Type	YT
<b>Vertical Setting (VERTICAL)</b>	
Vertical Scale	1 V
Vertical Offset	0.00 V
CH1 Switch	ON
CH2 Switch	OFF
CH3 Switch	OFF
CH4 Switch	OFF
Channel Coupling	DC
Bandwidth Limit	OFF
Probe Ratio	10X
Invert	OFF
Amplitude Scale	Coarse
Channel Unit	[V]
Display Label	OFF
Template Label	CH1
Delay Calibration	0.00 s

<b>Acquisition Setting (Acquire)</b>	
Acquisition Mode	Normal
Sin(x)/x	ON
Memory Depth	Auto
Anti-Aliasing	OFF
<b>Trigger Setting (TRIGGER)</b>	
Trigger Type	Edge
Source	CH1
Slope	Rising Edge
Trigger Mode	Auto
Trigger Coupling	DC
Trigger Holdoff	16 ns
Noise Reject	OFF
<b>Display Setting (Display)</b>	
Display Type	Vectors
Persistence Time	Min
Waveform Intensity	60%
Screen Grid	
Brightness	50%
<b>Signal Source (Source)<sup>[1]</sup></b>	
Source 1 Switch	OFF
Source 2 Switch	OFF
Status Display	OFF
<b>Source 1/Source 2 Setup</b>	
Waveform	Sine
Channel Switch	OFF
Frequency	1.00 kHz
Amplitude	5.000 V
Offset	0.000 $\mu$ V
Start Phase	0.0°
Modulation	OFF
Impedance	HighZ
<b>Cursor Setting (Cursor)</b>	
Mode	OFF
<b>Manual</b>	
Select	
Source	CH1
CursorA	-4.000 $\mu$ s
CursorB	4.000 $\mu$ s
Vertical Unit	Source

Horizontal Unit	s
<b>Track</b>	
CursorA Source	CH1
CursorB Source	CH1
CursorA	-4.000 $\mu$ s
CursorB	4.000 $\mu$ s
<b>XY</b>	
AX	2.000 V
BX	-2.000 V
AY	2.000 V
BY	-2.000 V
<b>Storage Setting (Storage)</b>	
Storage Type	Picture
<b>Utility Function Setting (Utility)</b>	
Sound	OFF
<b>Pass/Fail Test</b>	
Enable Test	OFF
Source	CH1
Operate	OFF
Mask Range	Screen Region
X Mask	0.02 div
Y Mask	0.96 div
Statistics Display	OFF
Stop On Fail	OFF
Output	
Aux Out	OFF
<b>System Setting</b>	
Vertical Reference	Ground
Power Set	Last
<b>Math Operation Setting (MATH→Math)</b>	
<b>A+B</b>	
Operation	OFF
Source A	CH1
Source B	CH1
Offset	0.00 V
Scale	1.00 V
<b>A-B</b>	
Operation	OFF
Source A	CH1
Source B	CH1
Offset	0.00 V



Scale	1.00 V
<b>A × B</b>	
Operation	OFF
Source A	CH1
Source B	CH1
Offset	0.00 U
Scale	2.00 U
<b>A/B</b>	
Operation	OFF
Source A	CH1
Source B	CH1
Offset	0.00 U
Scale	50.0 mU
<b>FFT</b>	
Operation	OFF
Source	CH1
Center Frequency	5.00 MHz
Horizontal Scale	5.00 MHz
Offset	0.00 dBV
Scale	10.0 dBV
Window Function	Rectangle
Mode	Trace
View	Half
Unit	dB/dBm
<b>A&amp;&amp;B</b>	
Operation	OFF
Source A	D0
Source B	D1
Offset	0.00 V
Scale	1.00 V
Threshold A	0.00 V
Threshold B	0.00 V
<b>A   B</b>	
Operation	OFF
Source A	D0
Source B	D1
Offset	0.00 V
Scale	1.00 V
Threshold A	0.00 V
Threshold B	0.00 V
<b>A ^ B</b>	
Operation	OFF
Source A	D0
Source B	D1

Offset	0.00 V
Scale	1.00 V
Threshold A	0.00 V
Threshold B	0.00 V
<b>!A</b>	
Operation	OFF
Source A	D0
Offset	0.00 V
Scale	1.00 V
Threshold A	0.00 V
<b>Intg</b>	
Operation	OFF
Source	CH1
Offset	0.00 U
Scale	10.0 $\mu$ U
<b>Diff</b>	
Operation	OFF
Source	CH1
Offset	0.00 V/s
Scale	50.0 MV/s
<b>Sqrt</b>	
Operation	OFF
Source	CH1
Offset	0.00 U
Scale	2.00 U
<b>Lg</b>	
Operation	OFF
Source	CH1
Offset	0.00 U
Scale	500 mU
<b>Ln</b>	
Operation	OFF
Source	CH1
Offset	0.00 U
Scale	1.00 U
<b>Exp</b>	
Operation	OFF
Source	CH1
Offset	0.00 U
Scale	5.00 U
<b>Abs</b>	
Operation	OFF
Source	CH1
Offset	0.00 V

Scale	50.0 V
<b>Filter</b>	
Operation	OFF
Source	CH1
Offset	0.00 V
Scale	1.00 V
Filter	Low Pass
Cutoff Frequency	500 kHz
<b>LA<sup>[2]</sup></b>	
Current Channel	None
D7-D0	OFF
D15-D8	OFF
Wave Size	S
ReOrder	D0-D15
Delay Calibration	0.00 s
<b>Switch Channel</b>	
Channel Selection	D7-D0
<b>Threshold Settings</b>	
Low Type	TTL
D7-D0	1.40 V
High Type	TTL
D15-D8	1.40 V
<b>Label</b>	
Select Channel	D0
Preset Label	ACK
<b>Protocol Decoding (MATH→ Decode 1/Decode 2)</b>	
Decoder	Parallel
Decode	OFF
Format	ASC
<b>Parallel</b>	
CLK	CH1
Edge	Rising Edge
Bus Width	8
Bit X	0
Channel	D0
<b>RS232</b>	
TX	CH1
Polarity	
Baud	9600
RX	OFF
Order	LSB
Data Bits	8

Stop Bit	1
Parity	None
<b>I2C</b>	
CLK	CH1
DATA	CH2
Address Mode	Normal
<b>SPI</b>	
CLK	CH1
MISO	OFF
MOSI	CH2
Mode	Timeout
Timeout	1.00 us
Edge	Rising Edge
Polarity	
Width	8
Order	MSB
<b>Decoding Configuration</b>	
Label	ON
Line	ON
Format	ON
Endian	OFF
Width	OFF
Data Source	Traces
<b>Reference Waveform Setting (REF)</b>	
Channel Setting	Ref1
Current Channel	Ref1
Source	CH1
Offset	0.00 nV
Scale	100 mV
Color	Light Gray

**Note**<sup>[1]</sup>: Only applicable to digital oscilloscopes with source channels.

**Note**<sup>[2]</sup>: Only applicable to MSO1000Z and DS1000Z Plus with the MSO upgrade option.

# Chapter 15 Accessibility Setting

The contents of this chapter:

- Remote Interface Configuration
- System-related

## Remote Interface Configuration

MSO1000Z/DS1000Z provides two remote control interfaces: USB Device (TMC and SICD static image capture devices share this interface) and LAN. The USB Device interface takes precedence over the LAN interface. You can press **Utility** → **IO Setting** → **RemoteIO** to select the desired communication interface according to the particular condition.

- When the USB Device interface is connected and press **Utility** → **IO Setting** → **USB Device** → "Computer", the system will select the USB Device interface automatically as the only valid interface no matter whether the LAN interface is connected or not. In the RemoteIO menu, the state of the TMC (USB Device) is "ON", and the state of the LAN is "OFF". The states of the interfaces are not allowed to be changed.
- When only the LAN interface is connected, the system will automatically detect the LAN interface. In the RemoteIO menu, the state of the LAN is "ON" by default, and you can press **LAN** softkey to turn "OFF" or "ON" the LAN interface. The state of the TMC (USB Device) is "OFF", and it is not allowed to make any change.

## LAN Configuration

Press **Utility** → **IO Setting** → **LAN Conf.** to turn on the LAN setting interface. You can view the network connection status and configure the network parameters.

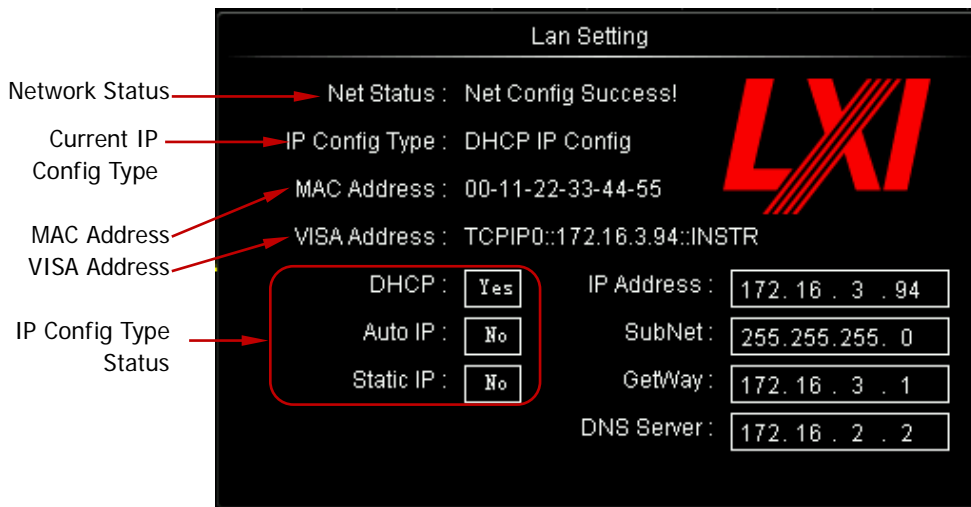

Figure 15-1 LAN Setting Interface

## Network Status



Connect the oscilloscope to your local area network using a network cable. The network interface of the oscilloscope is at the rear panel. The oscilloscope will give different prompts according to the current network connection status.

- Net Config Success!
- Acquire IP...
- IP Conflict!
- Unconnected!
- DHCP Fail!
- Read Status Fail!

## IP Configuration Type



The configuration type of the IP address can be DHCP, auto IP or static IP. In different IP configuration type, the configuration mode of the network parameters (such as the IP address) is different.

### DHCP

Press **Configure** and use  to select "DHCP". Then press down  to select this type. When DHCP is valid, the DHCP server in the current network will assign the network parameters (such as the IP address) for the oscilloscope.



### Auto IP

Press **Configure** and use  to select "Auto IP". Then press down  to select this type. When the auto IP type is valid, disable DHCP manually, **Gate** and **DNS** are added to the right side of the screen and users can define the gateway and DNS server address of the oscilloscope. In auto IP mode, the oscilloscope will get the IP address ranging from 169.254.0.1 to 169.254.255.254 and the subnet mask 255.255.0.0 automatically according to the current network configuration.

### Static IP

Press **Configure** and use  to select "Static IP". Then press down  to select this type. When this type is valid, disable DHCP and auto IP manually, **IP Address**,

**Mask**, **Gate** and **DNS** are added to the right of the screen. At this point, users can define their own network parameters (such as the IP address) of the oscilloscope.

### 1. Set the IP Address

The format of IP address is nnn.nnn.nnn.nnn. The range of the first nnn is from 0 to 255 (except 127); wherein, the valid range is from 0 to 223. The ranges of the other three nnn are from 0 to 255. You are recommended to ask your network administrator for an IP address available.

Press **IP Address** and use  to input the desired IP address. This setting will be saved in the non-volatile memory; if "**Power-off Recall**" is set to "Last" and **DHCP** and **Auto IP** are "Off" at the next power-on, the oscilloscope will load the preset IP address automatically.

### 2. Set the Subnet Mask

The format of the subnet mask is nnn.nnn.nnn.nnn; wherein, the range of the nnn is from 0 to 255. You are recommended to ask your network administrator for a subnet mask available.

Press **Mask** and use  to input the desired subnet mask. This setting will be saved in the non-volatile memory; if "**Power-off Recall**" is set to "Last" and **DHCP** and **Auto IP** are "Off" at the next power-on, the oscilloscope will load the preset subnet mask automatically.

## Set the Gate

You can set this paramter in Auto IP and Static IP mode.

The format of the gate is nnn.nnn.nnn.nnn; wherein, the range of the first nnn is from 0 to 223 (except 127) and the ranges of the other three nnn are from 0 to 255. You are recommended to ask your network administrator for a gate address available.

Press **Gate** and use  to input the desired gate address. This setting will be saved in the non-volatile memory; if "**Power-off Recall**" is set to "Last" and **DHCP** and **Auto IP** are "Off" at the next power-on, the oscilloscope will load the preset gate address automatically.

## Set the Domain Name Server

You can set this paramter in Auto IP and Static IP mode.

The address format of the domain name server is nnn.nnn.nnn.nnn; wherein, the range of the first nnn is from 0 to 223 (except 127) and the ranges of the other three nnn are from 0 to 255. You are recommended to ask your network administrator for an address available.



press **DNS** and use  to input the desired address. Generally, users do not need to set the DNS, therefore this parameter setting can be ignored.

**Tips**

- When the three IP configuration types are all turned on, the priority of the parameter configuration from high to low is "DHCP", "Auto IP" and "Static IP".
- The three IP configuration types cannot be all turned off at the same time.

## Apply the Network Parameter Setting

Press **Apply** to validate the current network parameter setting.

## Initialize the Network Parameters

Press **Initialize** to return the network parameters to the default state.

## MAC Address

For each oscilloscope, the MAC address is unique. When attributing IP address for the oscilloscope, the MAC address is usually used to identify the instrument.

## VISA Address

Display the VISA address currently used by the oscilloscope.

## USB Device

Press **Utility** → **IO Setting** → **USB Device** to select the device type ("Computer" or "PicBridge") connected to the USB device interface and the default is "Computer". When "Computer" is selected, the oscilloscope can communicate with the PC. When "PictBridge" is selected, you can print the content displayed on the screen via a PicBridge printer.



## System-related

### Sound

When the sound is enabled, you can hear the sound of the beeper when you press a function key or a menu softkey or when the prompt message pops up.

Press **Utility** → **Sound** to select  (off) or  (on). The default is off.

### Language

This oscilloscope supports menus in multiple languages as well as provides Chinese and English help information, prompt messages and interface display. Press **Utility** → **Language** and use  to select the desired language; then, press down  to select the language.

### System Information

Press **Utility** → **System** → **System Info** to view the system information of your oscilloscope. The system information includes the manufacturer, model, serial number as well as software version and board version.

### Vertical Reference

When rotating **VERTICAL**  **SCALE** to change the vertical scale of the analog channel, you can expand and compress the signal vertically around the screen center or signal ground level position.

Press **Utility** → **System** → **VerticalRef.** to select "Center" or "Ground". The default is "Ground".

- Center: when the vertical scale is changed, the waveform will be expanded or compressed around the screen center.
- Ground: when the vertical scale is changed, the waveform will be expanded or compressed around the signal ground level position.

## Power-off Recall

You can set the system configuration to be recalled when the oscilloscope is powered on again after power-off. Press **Utility** → **System** → **Power Set** to select "Last" or "Default".

- Last: return to the setting of the system at last power-off.
- Default: return to the factory setting of the system.

## Self-calibration

The self-calibration program can quickly make the oscilloscope reach the best working state to get the most precise measurement values. You can perform self-calibration at any time especially when the change of the environment temperature is up to or more than 5°C. Make sure that the oscilloscope has been warmed up or operated for more than 30 minutes before the self-calibration.

Disconnect all the input channel connections, and then press **Utility** → **Self-Cal** and the self-calibration interface as shown in the figure below is displayed.



Figure 15-2 Self-calibration Interface

Press **Start** and the oscilloscope will start to execute the self-calibration program. Press **Exit** to give up the self-calibration operation at any time and return to the previous menu.

**Note:** Most of the keys are disabled during the self-calibration.

## Print Setting

PictBridge is a new print standard. If your oscilloscope and the printer both comply with the PictBridge standard, you can connect the oscilloscope to the printer using a USB cable to print the screen image directly. Devices comply with the PictBridge standard always have the icon as shown in the figure on the right side.



MSO1000Z/DS1000Z digital oscilloscope supports the PictBridge printer function. Printers that support PictBridge can be connect directly via the USB Device connector at the rear panel of the oscilloscope. You can set the printer parameters using the oscilloscope to output the corresponding picture.

After connecting the printer, you need to first set the USB device type of the oscilloscope. Press **Utility** → **IO Setting** → **USB Device** to select "PictBridge". Then, press **Utility** → **Print Set** to set the print parameters.

### 1. Print

After setting the print parameters, press this key or press  at the front panel to execute the print operation.

### 2. Continue

When the print is paused, press this key to resume the unfinished print.

**Note:** This key is only available after the print is paused.

### 3. Abort

Pressing this key can stop the current print via the oscilloscope.

**Note:** This key is only available during the print process.

### 4. Status

Press this key and pop-up message box will be displayed on the screen showing the current print status.

### 5. Print Range

Press this key to set the print range to "Screen" or "Wave" and the default is "Screen".

- Screen: print the whole screen image.
- Wave: only print the waveform area.

### 6. Palette

Press this key to set the print color to "Gray Scale" or "Color" and the default is "Color".

## 7. Paper Size

Press this key to open the size list and rotate the multifunction knob  to select the desired paper size. You can also press this key continuously to switch among the options. The sizes include "Default", "A2", "A3", "A4", "A5", "A6" or "B5".

**Note:** The paper sizes available are related to the property of the printer connected. Sizes not supported by the printer cannot be selected.

## 8. File Type

Press this key to open the file type list and rotate the multifunction knob  to select the desired file type. You can also press this key continuously to switch among the options. The file types include "Default", "Jpeg" or "Bmp".

**Note:** The file types available are related to the property of the printer connected. File types not supported by the printer cannot be selected.

## 9. Print Quality

Press this key to open the print quality list and rotate the multifunction knob  to select the desired print quality. You can also press this key continuously to switch among the options. The print qualities include "Default", "Normal", "Draft" or "Fine".

**Note:** The print qualities available are related to the property of the printer connected. Print qualities not supported by the printer cannot be selected.

## 10. Copies

Press this key to set the number of copies to be printed. Rotate the multifunction knob  to select the desired number of copies. The range is from 1 to 999.

## 11. Invert

Press this key to set the print color invert to "ON" or "OFF" and the default is "OFF".

## Aux Output

Users can set the type of the signal output from the **[Trigger Out]** connector at the rear panel.

Press **Utility** → **Aux Out** to select the desired output type.

### 1. TrigOut

After this type is selected, the oscilloscope outputs a signal that can reflect the current capture rate of the oscilloscope at each trigger. Connect this signal to a waveform display device, measure the signal frequency and the measurement result equals the current acquisition rate.

### 2. PassFail

After this type is selected, the oscilloscope will output a negative pulse from this connector when a failed waveform is detected in the pass/fail test. The instrument will output low level continuously if no failure is detected.

## Option Management

This oscilloscope provides multiple options to fulfill your measurement requirements. To use the option functions, please order the corresponding options according to the order numbers provided in "**Appendix A: Accessories and Options**" in this manual. You can view the options currently installed on the oscilloscope or activate the newly bought option through this menu.

To install an option, an option license (each instrument corresponds to a license) is required. Option license is a 28-byte string consisting of uppercase English letters and numbers. After you purchase the desired option, you can get the corresponding key. Before installing an option, follow the steps below to generate the option license using the key.

- 1) Log in **RIGOL** official website ([www.rigol.com](http://www.rigol.com)); click **Customer Center** → **License Generate** to enter the software license generation interface.
- 2) Input the correct key, instrument serial number (press **Utility** → **System** → **System Info** to acquire the instrument serial number) and identifying code in the software license generation interface and press **Generate** to acquire the option license.

Press **Utility** → **Options** → **Installed** to view the options currently installed on the oscilloscope and their information. Press **Setup** to enter the option activation operation menu.

- Editor: press this softkey to select "ON" to turn on the option license input interface as shown in the figure below. Use  to select the character on the virtual keyboard and press down the knob to input the character.

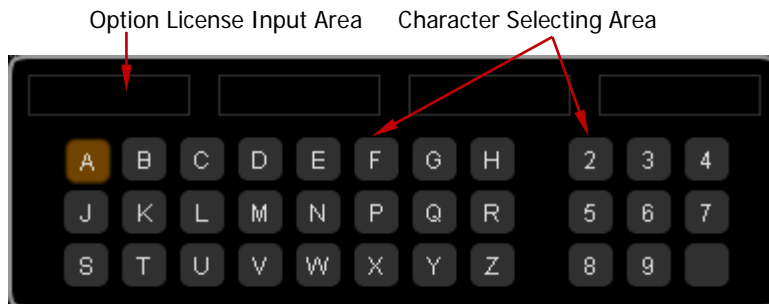

Figure 15-3 Option License Input Interface

- Backspace: press this softkey to delete the characters in the "Option License Input Area" from the right to the left.
- Clear: press this softkey to clear all the characters in the "Option License Input Area".
- Apply: press this softkey and the oscilloscope will activate the corresponding option using the option license currently input.

## Auto Options

As mentioned before, pressing **AUTO** at the front panel can enable the waveform automatic setting function. The oscilloscope will automatically adjust the vertical scale, horizontal time base and trigger mode according to the input signal to realize optimum waveform display. The oscilloscope allows users to set the related parameters of the waveform auto setting function.

Press **Utility** → **Auto Options** to enter the auto options setting menu. You can set the following parameters.

- Press **Lock** to lock **AUTO**. At this point, this key is disabled.  
**Note:** You can only unlock the key through the remote command (:SYSTem:AUToscale 1). For the remote command, please refer to *MSO1000Z/DS1000Z Programming Guide*.
- Press **Pk.Pk** to enable or disable the peak-peak priority function. When "ON" is selected, the peak-peak value is displayed on the screen with the best scale. For signals with offset, this function is more practical for observing signal variations.
- Press **CH** to select the channel to use the AUTO operation. You can select "OPENed" (the channel turned on currently) or "ALL". The default is "ALL".  
**Note:** If no channel is turned on currently, the instrument will execute the AUTO operation for all channels.
- Press **Menu Hold** to enable or disable the menu hold function. When "ON" is selected, the screen does not display the menus as shown in Figure 6-2 (namely the instrument holds the current menus) after the AUTO operation is successful.
- Press **Overlay** to enable or disable the overlay display function. When "ON" is selected and signals are input through multiple channels, the signals of multiple channels overlap on the screen. Each channel can occupy 8 grids of vertical range; amplitude resolution is small and the trigger is more stable. When "OFF" is selected, the signals of multiple channels are displayed on the screen respectively. Each channel can only copy about 2 grids of vertical range; amplitude resolution is large and the trigger is instable.
- Press **Coupling** to enable or disable the coupling hold function. When "ON" is selected, the channel coupling settings of the signal detected will be held. If the channel is set to DC coupling, the instrument keeps the DC coupling after the signal is detected; if the channel is set to AC coupling, the instrument keeps the AC coupling after the signal is detected; if the channel is set to GND, DC coupling is used by default. When "OFF" is selected, DC coupling is used by default after the signal is detected.

## Key Lock

Press **Utility** → **KeyLock** → **Lock** to lock all softkeys and buttons of the oscilloscope except the **Unlock** softkey. Press **Unlock** to unlock these keys.



# Chapter 16 Remote Control

MSO1000Z/DS1000Z oscilloscope can be controlled remotely mainly through the following two methods.

## User-defined programming

Users can program and control the oscilloscope by using the SCPI (Standard Commands for Programmable Instruments) commands. For more information about the commands and programming, refer to the *MSO1000Z/DS1000Z Programming Guide*.

## Use PC software

Users can use PC software to send commands to control the oscilloscope remotely. Ultra Sigma of **RIGOL** is recommended. You can download Ultra Sigma from **RIGOL** official website ([www.rigol.com](http://www.rigol.com)).

This oscilloscope can communicate with PC through USB or LAN instrument bus. This chapter gives a detailed introduction of how to use Ultra Sigma to control the oscilloscope remotely through various interfaces.

The contents of this chapter:

- Remote Control via USB
- Remote Control via LAN

## Remote Control via USB

### 1. Connect the device

Connect the USB Device interface of the oscilloscope at the rear panel with the USB Host interface of your PC using a USB cable.

### 2. Install the USB driver

This oscilloscope is a USB-TMC device. After you connect the oscilloscope to the PC and turn both on for the first time (the oscilloscope is automatically configured to USB interface; at the same time, make sure that **Utility** → **IO Setting** → **USB Device** is set to "Computer"), the **Found New Hardware Wizard** as shown in the figure below is displayed on the PC. Please install the "USB Test and Measurement Device (IVI)" driver following the directions in the wizard. The steps are as follows.

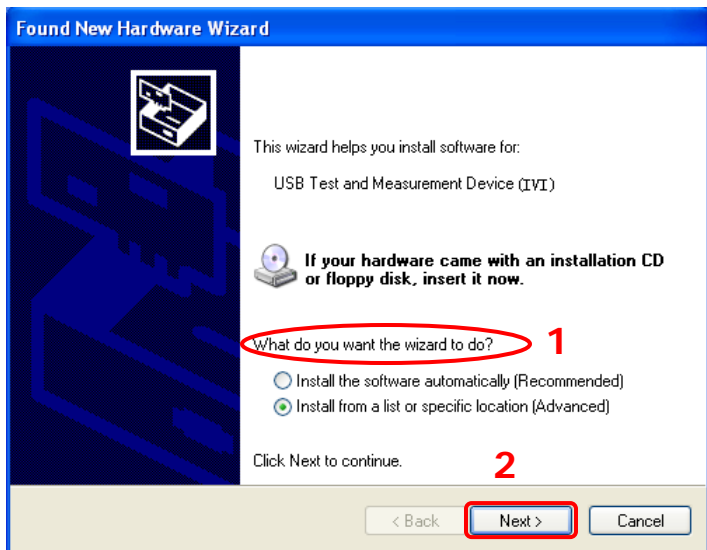

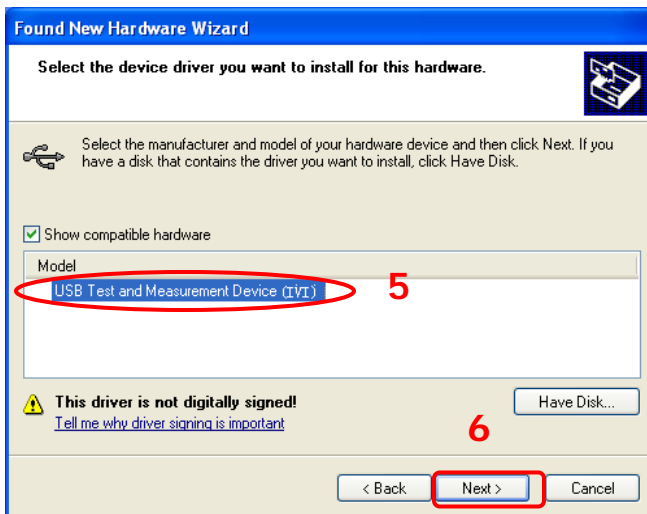
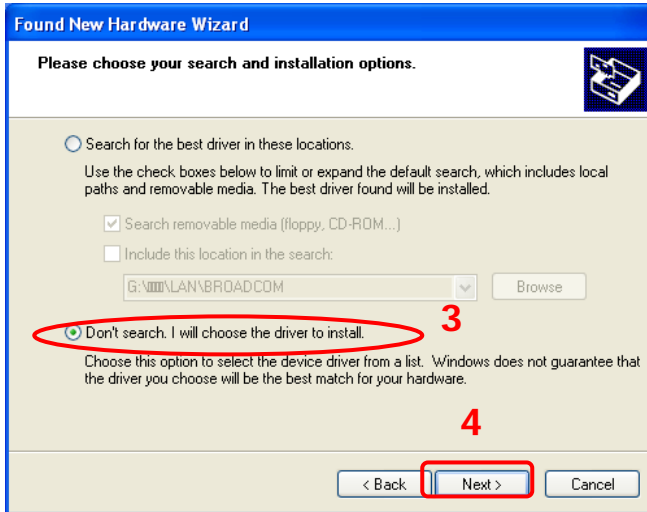

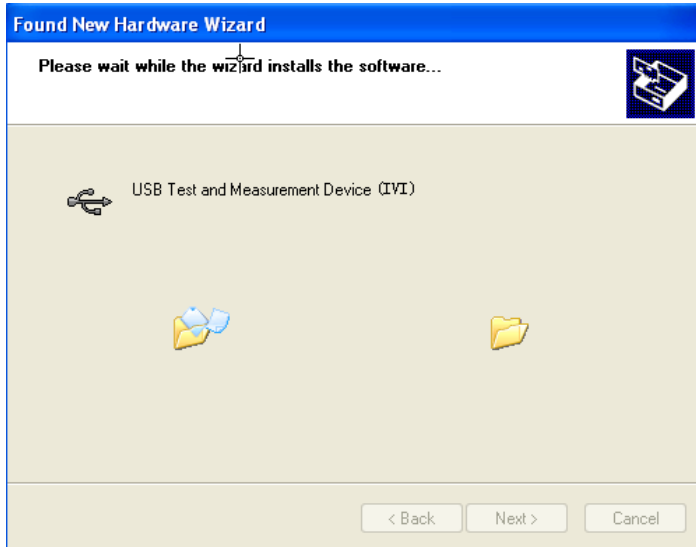

**3. Search for device resource**

Start up Ultra Sigma and the software will automatically search for the instrument resources currently connected to the PC via the USB interface. You can also click **USB-TMC** to search for the resources.

**4. View the device resource**

The resources found will appear under the "RIGOL Online Resource" directory and the model number and USB interface information of the instrument will also be displayed.

For example, MSO1104Z (USB0::0x1AB1::0x04CE::DS1ZD170800001::INSTR).

**5. Control the instrument remotely**

Right click the resource name "MSO1104Z (USB0::0x1AB1::0x04CE::DS1ZD170800001::INSTR)" and select "SCPI Panel Control" to turn on the remote command control panel through which you can send commands and read data.

## Remote Control via LAN

### 1. Connect the device

Connect the oscilloscope to your LAN using a network cable.

### 2. Configure network parameters

Configure the network parameters of the oscilloscope according to the description in "LAN Configuration".

### 3. Search for device resource

Start up Ultra Sigma, click **LAN** and the panel as shown in the figure below is displayed. Click **Search** and the instrument will automatically search for the instrument resource currently connected to the local network. The name of the instrument resource found will be displayed at the right side of the panel. You can click **OK** to add the instrument resource.

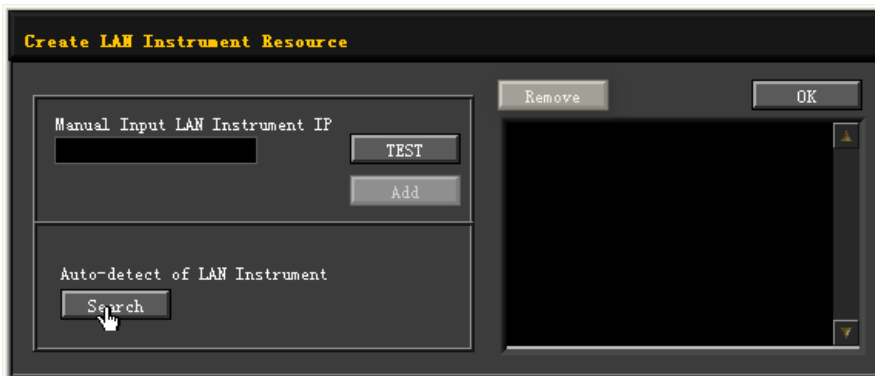

### 4. View the device resource

The resources found will appear under the "RIGOL Online Resource" directory. For example, MSO1104Z (TCPIP::172.16.3.94::INSTR).

### 5. Control the instrument remotely

Right click the resource name "MSO1104Z (TCPIP::172.16.3.94::INSTR)" and select "SCPI Panel Control" to turn on the remote command control panel through which you can send commands and read data.

### 6. Load LXI webpage

As this oscilloscope conforms to LXI CORE 2011 DEVICE standards, you can load LXI webpage through Ultra Sigma (right-click the instrument resource name and select "LXI-Web"). Various important information about the oscilloscope (including the model number, manufacturer, serial number, description, MAC address and IP address) will be displayed on the webpage. In addition, you can also load LXI webpage by directly inputting the IP address of the instrument into the address bar of the PC browser.

# Chapter 17 Troubleshooting

The commonly encountered failures and their solutions are listed below. When you encounter those problems, please solve them following the corresponding steps. If the problem remains still, please contact **RIGOL** and provide your device information (**Utility** → **System** → **System Info**).

**1. The screen is still dark (no display) after pressing the power key:**

- (1) Check whether the power switch is really on.
- (2) Check whether the power is correctly connected.
- (3) Check whether the fuse is burned out. If the fuse needs to be changed, please use the specified fuse.
- (4) Restart the instrument after finishing the above inspections.
- (5) If it still does not work correctly, please contact **RIGOL**.

**2. The signal is sampled but no waveform of the signal is displayed:**

- (1) Check whether the probe is correctly connected to the oscilloscope and item to be tested.
- (2) Check whether there are signals generated from the item to be tested (you can connect the probe compensation signal to the problematic channel to determine which has problem, the channel or the item to be tested).
- (3) Resample the signal.

**3. The tested voltage amplitude is greater or lower than the actual value (this problem usually occurs when probe is used):**

Check whether the probe ratio of the channel complies with the attenuation ratio of the probe.

**4. There is waveform display but not stable:**

- (1) Check the trigger source: press **MENU** (in the trigger control area (TRIGGER) at the front panel) → **Source** to check whether the trigger source selected complies with the signal channel actually used.
- (2) Check the trigger type: general signals should use "Edge" trigger and video signal should use "Video" trigger. Only when the proper trigger type is used, can the waveform be displayed stably.
- (3) Check the trigger level: adjust the trigger level to the middle of the signal.
- (4) Change the trigger holdoff setting.

**5. No display after pressing **RUN/STOP**:**

Check whether the trigger mode in the trigger control area (TRIGGER) at the front panel is "Normal" or "Single" and whether the trigger level exceeds the waveform range. If yes, set the trigger level to the middle or set **MODE** to "Auto".

**Note:** Using **AUTO** could automatically finish the above setting.

**6. The display of waveform is ladder-like:**

- (1) The horizontal time base might be too low. Increase the horizontal time base to increase the horizontal resolution and improve the display.
- (2) If the display type is "Vectors", the lines between the sample points may cause ladder-like display. Press **Display** → **Type** to set the display type to "Dots" to solve the problem.

**7. Fail to connect PC or PictBridge printer through USB:**

- (1) Press **Utility** → **IO Setting** → **USB Device** to check whether the current setting matches the device currently connected.
- (2) Check whether the USB cable is correctly connected to the oscilloscope and PC.
- (3) Check whether the USB cable is in good condition. If needed, restart the oscilloscope.

**8. The USB storage device cannot be recognized:**

- (1) Check whether the USB storage device can work normally.
- (2) Make sure that the USB storage device being used is flash memory type and FAT32 format. This oscilloscope does not support USB storage device of hard disk type.
- (3) Make sure whether the capacity of the USB storage device is too large. It is recommended that the capacity of the USB storage device being used with this oscilloscope is no larger than 8 GBytes.
- (4) Restart the instrument and then insert the USB storage device to check it.
- (5) If the USB storage device still cannot be used normally, please contact **RIGOL**.



## Chapter 18 Specifications

All the specifications are guaranteed except the parameters marked with "Typical" and the oscilloscope needs to operate for more than 30 minutes under the specified operation temperature.

### Sample

Sample Mode	Real-time Sample
Real Time Sample Rate	Analog channel: 1 GSa/s (single-channel), 500 Msa/s (dual-channel), 250 MSa/s (3/4-channel) Digital channel: 1 GSa/s (8-channel), 500 MSa/s (16-channel)
Peak Detect	Analog channel: 4 ns Digital channel: 4 ns
Averaging	After all the channels finish N samples at the same time, N can be 2, 4, 8, 16, 32, 64, 128, 256, 512 or 1024
High Resolution	12 bit (max)
Interpolation	Sin(x)/x (optional)
Min Detect Pulse Width	Digital channel: 10 ns
Memory Depth	Analog channel: standard 12M pts (single-channel), 6M pts (dual-channel), 3M pts (3/4-channel); optional 24 Mpts (single-channel), 12 Mpts (dual-channel), 6 Mpts (3/4-channel) Digital channel: standard 12 Mpts (8-channel)/6 Mpts (16-channel); optional 24 Mpts (8-channel)/12 Mpts (16-channel)

### Input

Number of Channels	MSO1XX4Z/1XX4Z-S: 4 analog channels, 3 analog channels + 8 digital channels, 2 analog channels + 16 digital channels DS1XX4Z Plus/1XX4Z-S Plus: 4 analog channels, MSO upgradable DS1054Z: 4 analog channels
Input Coupling	DC, AC or GND
Input Impedance	Analog channel: (1 M $\Omega$ ±1%)    (15 pF±3 pF) Digital channel: (100 k $\Omega$ ±1%)    (8 pF±3 pF)
Probe Attenuation Coefficient	Analog channel: 0.01X to 1000X, in 1-2-5 step
Maximum Input Voltage (1M $\Omega$ )	Analog Channel: CAT I 300 Vrms, CAT II 100 Vrms, Transient Overvoltage 1000 Vpk Digital channel: CAT I 40Vrms, Transient Overvoltage 800 Vpk

**Horizontal**

Timebase Scale	5 ns/div to 50 s/div
Max Record Length	24 Mpts (optional)
Timebase Accuracy <sup>[1]</sup>	≤±25 ppm
Clock Drift	≤±5 ppm/year
Max Delay Range	Negative delay: 1/2 (memory depth/sample rate) Positive delay: 1 s to 500 s
Timebase Mode	YT, XY, Roll
Number of X-Y	1
Waveform Capture Rate <sup>[2]</sup>	30,000 wfms/s (dots display)
Zero Offset	±0.5 div×minimum time base scale

**Vertical**

Bandwidth (-3 dB)	MSO1104Z/1104Z-S and DS1104Z Plus/1104Z-S Plus: DC to 100 MHz MSO1074Z/1074Z-S and DS1074Z Plus/1074Z-S Plus: DC to 70 MHz DS1054Z: DC to 50 MHz
Single-shot Bandwidth	MSO1104Z/1104Z-S and DS1104Z Plus/1104Z-S Plus: DC to 100 MHz MSO1074Z/1074Z-S and DS1074Z Plus/1074Z-S Plus: DC to 70 MHz DS1054Z: DC to 50 MHz
Vertical Resolution	Analog channel: 8 bit Digital channel: 1 bit
Vertical Scale (Probe ratio is 1X)	1 mV/div to 10 V/div
Offset Range (Probe ratio is 1X)	1 mV/div to 499 mV/div: ±2 V 500 mV/div to 10 V/div: ±100 V
Bandwidth Limit <sup>[1]</sup>	20 MHz
Low Frequency Response (AC Coupling, -3dB)	≤5 Hz (on BNC)
Calculated Rise Time <sup>[1]</sup>	MSO1104Z/1104Z-S and DS1104Z Plus/1104Z-S Plus: 3.5 ns MSO1074Z/1074Z-S and DS1074Z Plus/1074Z-S Plus: 5 ns DS1054Z: 7 ns

DC Gain Accuracy	<10 mV: $\pm 4\%$ full scale $\geq 10$ mV: $\pm 3\%$ full scale
DC Offset Accuracy	$\pm 0.1$ div $\pm 2$ mV $\pm 1\%$ offset value
Channel to Channel Isolation	DC to maximum bandwidth: $> 40$ dB

### Vertical (Digital Channel) (Applicable to MSO1000Z and DS1000Z Plus with MSO Upgrade Option)

Threshold	Adjustable threshold of 8 channels per group
Threshold Selection	TTL (1.4 V)
	5.0 V CMOS (+2.5 V), 3.3 V CMOS (+1.65 V)
	2.5 V CMOS (+1.25 V), 1.8 V CMOS (+0.9 V)
	ECL (-1.3 V)
	PECL (+3.7 V)
	LVDS (+1.2 V)
	0 V
	User
Threshold Range	$\pm 15.0$ V, 10 mV step
Threshold Accuracy	$\pm (100$ mV $+ 3\%$ threshold setting)
Dynamic Range	$\pm 10.0$ V + threshold
Minimum Voltage Swing	500 mVpp
Vertical Resolution	1 bit

### Trigger

Trigger Level Range	$\pm 5$ div from center of the screen
Trigger Mode	Auto, Normal, Single
Holdoff Range	16 ns to 10 s
High Frequency Rejection <sup>[1]</sup>	75 kHz
Low Frequency Rejection <sup>[1]</sup>	75 kHz
Trigger Sensitivity <sup>[1]</sup>	1.0 div (below 5 mV or noise rejection is enabled) 0.3 div (above 5 mV and noise rejection is disabled)

### Edge Trigger

Edge Type	Rising, Falling, Rising/Falling
-----------	---------------------------------

### Pulse Trigger

Pulse Condition	Positive Pulse Width (greater than, lower than, within specific interval) Negative Pulse Width (greater than, lower than, within specific interval)
Pulse Width	8 ns to 10 s
<b>Runt Trigger (Optional)</b>	
Pulse Width Condition	None, >, <, <>
Pulse Polarity	Positive, Negative
Pulse Width Range	8 ns to 10 s
<b>Window Trigger (Optional)</b>	
Window Type	Rising, Falling, Rising/Falling
Trigger Position	Enter, Exit, Time
Window Time	8 ns to 10 s
<b>Nth Edge Trigger (Optional)</b>	
Edge Type	Rising, Falling
Idle Time	16 ns to 10 s
Edge Number	1 to 65535
<b>Slope Trigger</b>	
Slope Condition	Positive Slope (greater than, lower than, within specific interval) Negative Slope (greater than, lower than, within specific interval)
Time Setting	8 ns to 10 s
<b>Video Trigger</b>	
Signal Standard	NTSC, PAL/SECAM, 480P, 576P
<b>Pattern Trigger</b>	
Pattern Setting	H, L, X, Rising, Falling
<b>Delay Trigger (Optional)</b>	
Edge Type	Rising, Falling
Delay Type	>, <, <>, ><
Delay Time	8 ns to 10 s
<b>TimeOut Trigger (Optional)</b>	
Edge Type	Rising, Falling, Rising/Falling
Timeout time	16 ns to 10 s
<b>Duration Trigger</b>	
Pattern	H, L, X
Trigger Condition	>, <, <>
Duration Time	8 ns to 10 s
<b>Setup/Hold Trigger (Optional)</b>	
Edge Type	Rising, Falling

Data Type	H, L, X
Setup Time	8 ns to 1 s
Hold Time	8 ns to 1 s
<b>RS232/UART Trigger (Optional)</b>	
Polarity	Normal, Invert
Trigger Condition	Start, Error, Check Error, Data
Baud Rate	2400 bps, 4800 bps, 9600 bps, 19200 bps, 38400 bps, 57600 bps, 115200 bps, 230400 bps, 460800 bps, 921600 bps, 1 Mbps and User
Data Bits	5 bit, 6 bit, 7 bit, 8 bit
<b>I2C Trigger (Optional)</b>	
Trigger Condition	Start, Restart, Stop, Missing ACK, Address, Data, A&D
Address Bits	7 bits, 8 bits, 10 bits
Address Range	0 to 127, 0 to 255, 0 to 1023
Byte Length	1 to 5
<b>SPI Trigger (Optional)</b>	
Trigger Condition	Timeout, CS
Timeout Value	16 ns to 10 s
Data Bits	4 bit to 32 bit
Data Line Setting	H, L, X

## Measure

Cursor	Manual Mode	Voltage Deviation between Cursors ( $\Delta V$ ) Time Deviation between Cursors ( $\Delta T$ ) Reciprocal of $\Delta T$ (Hz) ( $1/\Delta T$ )
	Track Mode	Voltage and Time Values of the Waveform Point
	Auto Mode	Allow to display cursors during auto measurement
Auto Measurement	<p>Analog channel:            Period, Frequency, Rise Time, Fall Time, Positive Pulse Width, Negative Pulse Width, Positive Duty Cycle, Negative Duty Cycle, Positive Pulse Count, Negative Pulse Count, Rising Edge Count, Falling Edge Count, <math>tV_{max}</math>, <math>tV_{min}</math>, Positive Rate, Negative Rate, Delay <math>f1 \rightarrow 2</math>, Delay <math>\bar{1} \rightarrow 2</math>, Phase <math>f1 \rightarrow 2</math>, Phase <math>\bar{1} \rightarrow 2</math>, Maximum, Minimum, Peak-Peak Value, Top Value, Bottom Value, Amplitude, Upper Value, Middle Value, Lower Value, Average, Vrms, Overshoot, Pre-shoot, Area, Period Area, Period Vrms, Variance</p> <p>Digital channel:            Period, Frequency, Positive Pulse Width, Negative Pulse Width, Positive Duty Cycle, Negative Duty Cycle, Delay <math>f1 \rightarrow 2</math>, Delay <math>\bar{1} \rightarrow 2</math>, Phase <math>f1 \rightarrow 2</math>, Phase <math>\bar{1} \rightarrow 2</math></p>	

Number of Measurements	Display 5 measurements at the same time
Measurement Range	Screen or cursor
Measurement Statistic	Average, Max, Min, Standard Deviation, Number of Measurements
Frequency Counter	Hardware 6 bit frequency counter (channels are selectable)

### Math Operation

Waveform Operation	A+B, A-B, A×B, A/B, FFT, A&&B, A  B, A^B, !A, Intg, Diff, Sqrt, Lg, Ln, Exp, Abs, Filter
FFT Window Function	Rectangle, Hanning, Blackman, Hamming, Flat Top, Triangle
FFT Mode	Trace, Memory
FFT Display	Half, Full
FFT Vertical Scale	dB/dBm, Vrms
Filter	Low Pass Filter, High Pass Filter, Band Pass Filter, Band Stop Filter
Number of Buses for Decoding	2
Decoding Type	Parallel (standard), RS232/UART (optional), I2C (optional), SPI (optional)

### Display

Screen Type	7.0 inch (203 mm) TFT LCD display
Display Resolution	800 Horizontal×RGB×480 Vertical Pixel
Display Color	16 Million Color (24 bit true color)
Persistence Time	Min, 100 ms, 200 ms, 500 ms, 1 s, 5 s, 10 s, Infinite
Display Type	Dots, Vectors

### I/O

Standard Ports	USB Host, USB Device, LAN, Aux Output (TrigOut/PassFail)
----------------	----------------------------------------------------------

### Signal Source (Applicable to Digital Oscilloscopes with Source Channels)

Channels	2
Sample Rate	200 MSa/s
Vertical Resolution	14 bits
Max. Frequency	25 MHz

Standard Waveform	Sine, Square, Pulse, Ramp, Noise, DC	
Built-in Waveform	Sinc, Exponential Rise, Exponential Fall, ECG, Gauss, Lorentz, Haversine	
Sine	Frequency Range	0.1 Hz to 25 MHz
	Flatness	$\pm 0.5$ dB (relative to 1 kHz)
	Harmonic Distortion	-40 dBc
	Stray (Non-harmonic)	-40 dBc
	Total Harmonic Distortion	1%
	S/N Ratio	40 dB
Square/Pulse	Frequency Range	Square: 0.1 Hz to 15 MHz Pulse: 0.1 Hz to 1 MHz
	Rise/Fall Time	<15 ns
	Overshoot	<5%
	Duty Cycle	Square: always be 50% Pulse: 10% to 90% adjustable
	Duty Cycle Resolution	1% or 10 ns (the larger of the two)
	Min. Pulse Width	20 ns
	Pulse Width Resolution	10 ns or 5 bits (the larger of the two)
	Jitter	500 ps
Ramp	Frequency Range	0.1 Hz to 100 kHz
	Linearity	1%
	Symmetry	0 to 100%
Noise <sup>[1]</sup>	Bandwidth	25 MHz
Built-in Waveform	Frequency Range	0.1 Hz to 1 MHz
Arbitrary Waveform	Frequency Range	0.1 Hz to 10 MHz
	Waveform Length	2 to 16k points
Frequency	Accuracy	100 ppm (lower than 10 kHz) 50 ppm (higher than 10 kHz)
	Resolution	0.1 Hz or 4 bits, the larger of the two
Amplitude	Output Range	20 mVpp to 5 Vpp, HighZ 10 mVpp to 2.5 Vpp, 50 $\Omega$
	Resolution	100 $\mu$ V or 3 bits, the larger of the two
	Accuracy	2% (1 kHz)
DC Offset	Range	$\pm 2.5$ V, HighZ $\pm 1.25$ V, 50 $\Omega$
	Resolution	100 $\mu$ V or 3 bits, the larger of the two
	Accuracy	2% (1 kHz)

## General Specifications

### Probe Compensation Output

Output Voltage <sup>[1]</sup>	About 3 V, peak-peak
-------------------------------	----------------------

Frequency <sup>[1]</sup>	1 kHz
--------------------------	-------

### Power

Power Voltage	100 V-240 V, 45 Hz-440 Hz
---------------	---------------------------

Power	Maximum 50 W
-------	--------------

Fuse	2 A, T degree, 250 V
------	----------------------

### Environment

Temperature	Operating: 0 °C to +50 °C
-------------	---------------------------

Range	Non-operating: -40 °C to +70 °C
-------	---------------------------------

Cooling Method	Fan cooling
----------------	-------------

Humidity Range	0 °C to +30 °C: ≤95% Relative Humidity
----------------	----------------------------------------

+30 °C to +40 °C: ≤75% Relative Humidity
------------------------------------------

+40 °C to +50 °C: ≤45% Relative Humidity
------------------------------------------

Altitude	Operating: under 3,000 meters
----------	-------------------------------

Non-operating: under 15,000 meters
------------------------------------

### Physical Characteristics

Size <sup>[3]</sup>	Width×Height×Depth=313.1 mm×160.8 mm×122.4 mm	
---------------------	-----------------------------------------------	--

Weight <sup>[4]</sup>	Package Excluded	3.2 kg±0.2 kg
-----------------------	------------------	---------------

Package Included	3.8 kg±0.5 kg
------------------	---------------

### Calibration Interval

The recommended calibration interval is one year.

### Regulatory Information

Electromagnetic	2004/108/EC
-----------------	-------------

Compatibility	Execution standard EN 61326-1:2006 EN 61326-2-1:2006
---------------	------------------------------------------------------

Safety	UL 61010-1:2004; CAN/CSA-C22.2 NO. 61010-1-2004; EN 61010-1:2001; IEC 61010-1:2001
--------	---------------------------------------------------------------------------------------

**Note<sup>[1]</sup>:** Typical.

**Note<sup>[2]</sup>:** Maximum value. 50ns, single-channel mode, dots display, auto memory depth.

**Note<sup>[3]</sup>:** Supporting legs and handle folded, knob height included.

**Note<sup>[4]</sup>:** Standard configuration.



# Chapter 19 Appendix

## Appendix A: Accessories and Options

	Description	Order Number
<b>Models</b>	DS1104Z Plus (100 MHz, 4 analog channels, MSO ready)	DS1104Z Plus
	DS1104Z-S Plus (100 MHz, 4 analog channels, 2-channel 25 MHz signal source, MSO ready)	DS1104Z-S Plus
	DS1074Z Plus (70 MHz, 4 analog channels, MSO ready)	DS1074Z Plus
	DS1074Z-S Plus (70 MHz, 4 analog channels, 2-channel 25 MHz signal source, MSO ready)	DS1074Z-S Plus
	MSO1104Z (100 MHz, 4 analog channels, 16 digital channels)	MSO1104Z
	MSO1104Z-S (100 MHz, 4 analog channels, 16 digital channels, 2-channel 25 MHz signal source)	MSO1104Z-S
	MSO1074Z (70 MHz, 4 analog channels, 16 digital channels)	MSO1074Z
	MSO1074Z-S (70 MHz, 4 analog channels, 16 digital channels, 2-channel 25 MHz signal source)	MSO1074Z-S
	DS1054Z (50 MHz, 4 analog channels)	DS1054Z
<b>Standard Accessories</b>	Power Cord conforming to the standard of the country	-
	USB Cable	CB-USBA-USBB-FF-150
	4 Passive Probes (150 MHz)	PVP2150
	1 Logic Analyzer Probe (only for MSO1000Z)	RPL1116
	Quick Guide (Hard Copy)	-
<b>MSO Upgrade Option</b>	MSO upgrade package for DS1000Z Plus only, including logic analyzer probe (RPL1116) and model label	MSO1000Z Upgrade Package
<b>Optional Accessory</b>	Rack Mount Kit	RM-DS1000Z
<b>Memory Depth Option</b>	Analog channel: 24 Mpts (with a single channel on)/12 Mpts (with two channels on)/6 Mpts (with three/four channels on) Digital channel: 24 Mpts (8-channel)/12 Mpts (16-channel)	MEM-DS1000Z
<b>Waveform Record Option</b>	This option provides the waveform record and playback function.	REC-DS1000Z
<b>Advanced Trigger Option</b>	RS232/UART trigger, I2C trigger, SPI trigger, Runt trigger, Window trigger, Nth edge trigger, delay trigger, timeout trigger, Setup/Hold trigger	AT-DS1000Z
<b>Serial Protocol Analysis Option</b>	RS232/UART, I2C and SPI trigger and decoding functions	SA-DS1000Z

**Note:** All the options or accessories can be ordered from you local **RIGOL** Office.

## Appendix B: Warranty

**RIGOL** warrants that the product mainframe and product accessories will be free from defects in materials and workmanship within the warranty period.

If a product proves defective within the respective period, **RIGOL** guarantees free replacement or repair of any defective products within a reasonable period of time. To get repair service, please contact with your nearest **RIGOL** sales or service office.

There is no other warranty, expressed or implied, except such as is expressly set forth herein or other applicable warranty card. There is no implied warranty of merchantability or fitness for a particular purpose. Under no circumstances shall **RIGOL** be liable for any consequential, indirect, ensuing or special damages for any breach of warranty in any case.

# Index

- +Duty ..... 6-26
- +Edges ..... 6-27
- +Pulses ..... 6-27
- +Rate ..... 6-30
- +Width ..... 6-26
- Acquisition Mode ..... 4-2
- AM ..... 13-16
- amplitude ..... 13-2
- Antialiasing ..... 4-7
- Area ..... 6-30
- Auto IP ..... 15-3
- Aux Output ..... 15-10
- Average ..... 4-2
- Bandwidth Limit ..... 2-3
- Blackman ..... 6-8
- Built-in Waveform ..... 13-6
- Channel Coupling ..... 2-2
- Channel Label ..... 2-5
- CSV ..... 14-3
- DC ..... 13-5
- DC offset voltage ..... 13-2
- Delay ..... 6-28
- Delay Calibration ..... 2-7
- Delay Trigger ..... 5-25
- Delayed Sweep ..... 3-2
- digital channel ..... 7-1
- Domain Name Server ..... 15-4
- Dots ..... 12-2
- Duration Trigger ..... 5-17
- Duty ..... 6-26
- Duty cycle ..... 13-5
- ECG ..... 13-8
- Edge Trigger ..... 5-7
- edge type ..... 5-7
- Edge Type ..... 5-30
- Edges ..... 6-27
- ExpFall ..... 13-7
- ExpRise ..... 13-7
- Factory ..... 14-12
- Fall Time ..... 6-26
- FFT Mode ..... 6-8
- Flattop ..... 6-8
- FM ..... 13-17
- Freq ..... 6-26
- frequency ..... 13-2
- Frequency Counter ..... 6-31
- Gate ..... 15-4
- Gauss ..... 13-8
- Hamming ..... 6-8
- Hanning ..... 6-8
- Haversine ..... 13-9
- High Resolution ..... 4-3
- I2C Decoding ..... 8-12
- I2C Trigger ..... 5-34
- Idle Time ..... 5-31
- impedance ..... 13-3
- interpolation ..... 13-14
- IP Address ..... 15-4
- LAN ..... 15-2
- logic analyzer ..... 1-13
- Lorentz ..... 13-8
- MAC ..... 15-5
- Memory Depth ..... 4-6
- Modulating Waveform ..... 13-16
- Modulation ..... 13-15
- Modulation Depth ..... 13-17
- Modulation Deviation ..... 13-18
- Modulation Frequency ..... 13-16
- Network Status ..... 15-3
- Noise ..... 13-6
- Noise Rejection ..... 5-5
- Normal ..... 4-2
- Nth Edge Trigger ..... 5-30
- Overshoot ..... 6-30
- Parallel Decoding ..... 8-2
- Parameters ..... 14-3
- Pattern Setting ..... 5-15, 5-17
- Peak Detect ..... 4-2
- Per.Area ..... 6-30
- Per.Vrms ..... 6-30
- Period ..... 6-26
- Persistence Time ..... 12-2
- Phase ..... 6-28
- Picture ..... 14-2
- Preshoot ..... 6-30
- Probe Ratio ..... 2-3

Pulse .....	13-5	Trigger Coupling.....	5-4
Pulse Condition .....	5-8	Trigger Holdoff.....	5-5
Pulse Polarity .....	5-21	Trigger Level.....	5-7
Pulse Trigger .....	5-8	Trigger Mode .....	5-3
Pulse Width Setting.....	5-9	Trigger Position.....	5-23
-Pulses .....	6-27	Trigger Source .....	5-2
Qualifier .....	5-21	tVmax .....	6-26
Ramp .....	13-4	tVmin.....	6-26
-Rate.....	6-30	USB .....	15-5
Rectangle .....	6-8	Vamp .....	6-29
Rise Time .....	6-26	Variance.....	6-30
Roll .....	3-5	Vavg .....	6-29
RS232 Decoding.....	8-7	Vbase .....	6-29
RS232 Trigger .....	5-32	Vectors .....	12-2
Runt Trigger.....	5-21	Vertical Scale .....	2-4
Sample Rate .....	4-4	Vertical Window .....	5-11, 5-22
Setup/Hold Trigger .....	5-28	Video Polarity .....	5-13
Setups.....	14-3	Video Standard .....	5-13
Sin(x)/x .....	4-4	Video Trigger .....	5-13
Sinc.....	13-7	VISA .....	15-5
Sine .....	13-2	Vlower .....	6-29
Slope Condition .....	5-10	Vmax .....	6-29
Slope Trigger.....	5-10	Vmid.....	6-29
SPI Decoding .....	8-15	Vmin.....	6-29
SPI Trigger.....	5-37	Vpp .....	6-29
Square .....	13-3	Vrms.....	6-29
start phase .....	13-2	Vtop .....	6-29
Static IP .....	15-3	Vupper.....	6-29
Subnet Mask .....	15-4	Waveform Confusion .....	4-4
Symmetry.....	13-4	Waveform Distortion.....	4-4
Sync.....	5-13	Waveform Leakage.....	4-5
Threshold .....	6-32	Waves.....	14-3
Time Setting .....	5-11	-Width .....	6-26
To Create Waveform .....	13-12	Window Function .....	6-7
To Edit Waveform .....	13-14	Window trigger .....	5-23
To Select Waveform .....	13-11	Window Type.....	5-23
Traces .....	14-2	XY Mode .....	3-3
Triangle .....	6-8	YT Mode .....	3-3